



CATALOG

LED LIGHTING

SERIES

Driver & Switch

iLighting Global Enterprise Co., Ltd.

Office Address: Room B3, 18/F Bonsun Industrial Building,
364-366 Sha Tsui Road, Tsuen Wan, HongKong

Phone: 852-3107 7500

Fax: 852-3544 0462

Email: info@ilighting.com.hk

Website: www.ilighting.com.hk



Driver & Switch

LED Lighting Series



CONTENTS

Company Profile 公司簡介	1-2
Lighting Basic Concept 照明基本概念	3-6
Control Panel 控制面板	7-10
LED Driver LED驅動器	11-15
Switch Series 輕觸開關	16-22

Driver
Sensor
Switch



A Control panel 控制面板



P.08
CP-YF



P.09
CP-TE



P.10
CP-D

B LED driver LED驅動器



P.12
DC-010



P.13
DC-LT-TR



P.14
DC-LT-DA



P.15
LT

C Switch Series 開關系列



P.17
TS-L201



P.18
TS-L106A



P.19
MS-PIR



P.20
SW-BL



P.21
TS-H201



P.21
TS-L301



P.21
TS-9019



P.21
TS-L501



P.22
TS-SHID20



P.22
TS-L1400



P.22
TS-L086



P.22
TS-L048



Company Profile

公司簡介

ABOUT US 關於我們

iLIGHTING Global Enterprise Co. Ltd. emerges as a professional and high-end lighting designer, manufacturer and supplier established in Hong Kong and Mainland China under the Brand name 'iLighting' since 2007. The company is also a strategic OEM/ODM partner of many organization-wide lighting brands. The company devotes herself in the development, manufacturing and marketing of green, low-carbon and energy-saving lighting products. With continuous investment on R&D, we are proud to provide a wide range of LED products and work with worldwide partners in developing and managing Energy Management System (EMS) through the application of 5G and WiFi technology.

iLIGHTING智能全球企業有限公司自2007年起成為一家專業的高端照明設計師、製造商和供應商。自在香港和中國大陸以“iLighting”的名字成立以來，公司也成為了許多照明品牌的戰略性OEM/ODM合作夥伴。公司致力於綠色、低碳、節能照明產品的開發、製造和銷售，憑藉對研發的持續投資，我們自豪地提供範圍廣泛的LED產品，並通過應用5G和WiFi科技與全球合作夥伴合作開發和管理能源管理系統(EMS)。

Product Capacity 生產能力

- LED lighting with integrated design and built-in advanced electronic driver for building lighting retrofit.
- LED indoor and outdoor lighting with internal and external drivers.
- LED lighting emergency fitting and charging packs.
- Extra long life LED lamps for high power high bay and flood lights.
- Total system solution for dimming lighting control deploying WiFi, DALI, Lonwork, Bluetooth 4.0, Zigbee technologies.
- OEM / ODM energy saving lighting as required by clients for new and retrofit installation.
- Total Energy Management Solution for Intelligent Building Management.
- LED照明與集成設計和內置先進的電子驅動器，用於建築照明改造。
- 室內和室外LED照明，有內部和外部驅動器。
- LED照明應急配件和充電器。
- 超長壽命LED燈，適用於大功率高位燈和泛光燈。
- 全系統調光照明控制解決方案，採用WiFi、DALI、Lonwork, Bluetooth 4.0, Zigbee 通訊技術。
- OEM/ODM節能照明，可根據客戶的要求進行更新改造。
- 智能建築管理總能源管理解決方案。

Our Mission 我們的使命

We look to serve our client with the best quality of products and viable solutions of energy management system through intelligent system integration. Product adaptability is our strength; continuous improvement is our norm of work and meeting customer satisfaction is our goal.

我們希望通過智能系統集成，為客戶提供最優質的產品和可行的能源管理系統解決方案。產品適應性是我們的優勢，持續改進是我們的工作準則，滿足客戶滿意是我們的目標。

Our Advantages 我們的優勢

- Excellent after-sale services.
- OEM and ODM for global lighting companies.
- Flexible design and tailor-made products to suit retrofit projects.
- 優良的售後服務。
- 為全球照明公司提供OEM和ODM。
- 靈活的設計和訂制的產品，以適應更新改造項目。

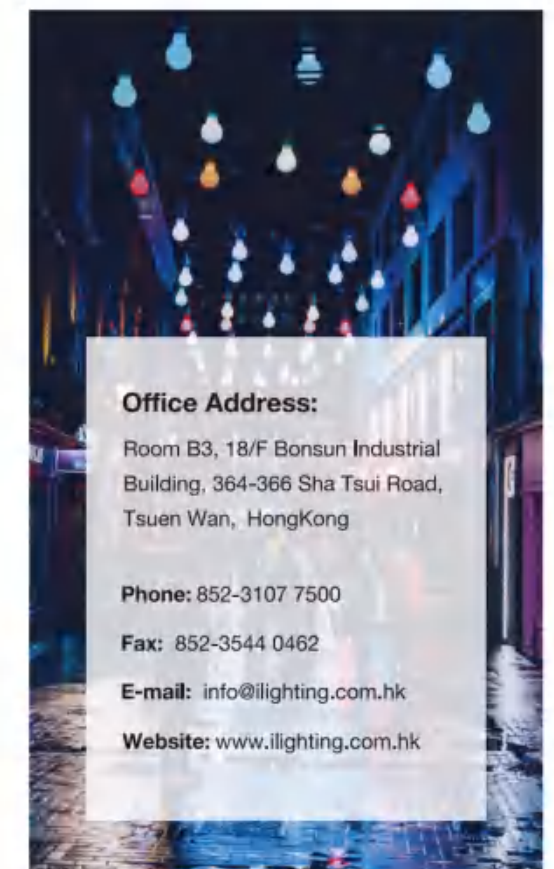

Office Address:

Room B3, 18/F Bonsun Industrial Building, 364-366 Sha Tsui Road, Tsuen Wan, HongKong

Phone: 852-3107 7500

Fax: 852-3544 0462

E-mail: info@ilighting.com.hk

Website: www.ilighting.com.hk

Lighting Basic Concept

照明基本概念



Lumen 流明

Lumen 實際上是代表著光的強度，也就是光通量 (Luminous flux) 即指光源在某單位時間內所發出之光線總數量。一般稱作光束)的單位，簡而言之，流明就是光束照在物體表面的量。

Lumen actually represents the intensity of lights. that is, the luminous flux(Luminous Flux) refers to the unit of the total amount of light emitted by a light source in a unit time, generally referred to as the light beam. In short, lumens is the light beam Amount on the surface of the object.

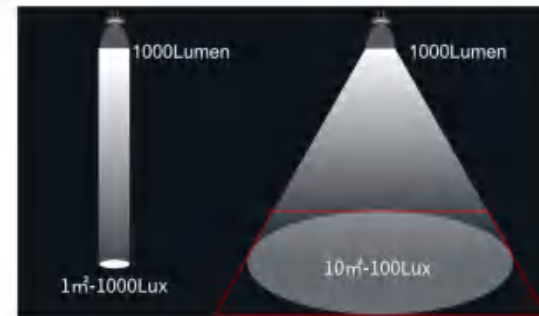

Color Rendering Index 顯色性指數

顯色度以Ra來表示，天然光的顯色度為100Ra，顯色度越接近100Ra，我們看到的顏色就越接近物體的自然原色。也就是顏色逼真的程度，顯色度高 我們所看到的顏色也就是較接近自然原色，顯色度低對於顏色的表現較差，所看到的顏色偏差也延遲。

Color rendering is represented by Ra, the color rendering of natural light is 100 Ra, the closer the color rendering is to 100 Ra, the color we see is closer to the natural primary color of the object. Color is realistic. The degree of color rendering is high. The color we see is close to natural primary color, low color rendering, poor performance for color. The color deviation seen is also delayed.

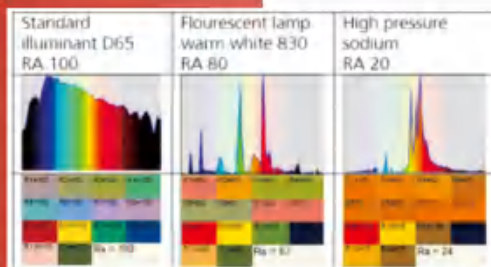

Color Temperature 色溫

色溫及不同色溫應用什麼環境——以絕對溫度 K (kelvin)來表示，色溫度 3000k以下時，光色有偏紅的現象(黃光)，給予一種溫暖、親切、舒適的感覺；色溫度超過 5000k時，顏色則偏向藍光(白光)，給人一種清冷的感覺，令環境變得清冷和寧靜。

通常亞熱帶人較喜歡清冷 4000k以上，而寒帶的人較喜歡 4000k以下的色溫度。

Color temperature and what environment is used for different color temperatures-expressed in absolute temperature K (kelvin), when the color temperature is below 3000k, the light color has a reddish phenomenon (yellow light), giving a warm, friendly, comfortable feeling; color temperature exceeds 5000k At this time, the color is biased towards blue light (white light), giving a cool feeling. Make the environment clear and peaceful.

Generally, people in the subtropics prefer cold temperatures above 4000k, while those in the cold regions prefer colors below 4000k.

WB SETTINGS	COLOR TEMPERATURE	LIGHT SOURCES
	10000-15000K	Clear Blue Sky
	6500-8000K	Cloudy Sky / Shade
	6000-7000K	Noon Sunlight
	5500-6500K	Average Daylight
	5000-5500K	Electronic Flash
	4000-5000K	Fluorescent Light
	3000-4000K	Early AM/ Late PM
	2500-3000K	Domestic Lighting
	1000-2000K	Candle Flame



Life 壽命

分為平均壽命和經濟壽命兩種，以小時為單位。

平均壽命 (rate average life)

例如，每個100個燈泡同時亮著，若6000小時後，第50個燈泡壞掉熄滅，此燈泡的平均壽命則為6000小時。

經濟壽命 (economic life)

指流明輸出的總時數

以上，燈的光通維持率達到標準規定的要求並能繼續燃點至50%的燈(即50%的燈失效時的壽命)，同時考慮損壞以及光束輸出衰減的狀況下能維持光源為70%以上。

Divided into two types of average life and economic life, in hours.

Life expectancy (rate average life)

For example, each of the 100 light bulbs is on at the same time. If after 60,000 hours, The 50th lamp is broken and extinguished, and the average life of the lamp is 60000 hours.

Economic life

Economic life refers to lumen output.

The above, The lumen maintenance rate of the indicator lamp meets the requirements of the standard that can continue burning point to 50% of lamps (ie, that point at 50% of lamp fails). Taking into account for the damage, lumen output decay, it can maintain light source at 70% healthy condition.

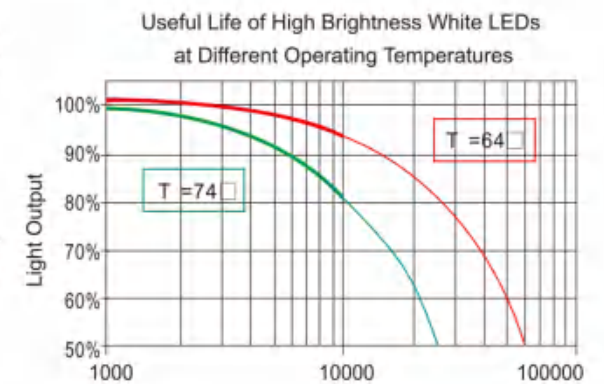

Fire Proof Material 物料防火等級

塑料阻燃等級由 HB, V-2, V-1向V-0逐級遞增。

HB: UL94標準中最低的阻燃等級，要求對於3到13毫米厚的樣品，燃燒速度小於 40毫米每分鐘；小於 3毫米厚的樣品，燃燒速度小於 70毫米每分鐘；或者在 100毫米的標誌前熄滅。

- V-2: 對樣品進行兩次 10秒的燃燒測試後, 火焰在 30秒內熄滅, 可以引燃 30cm下方的藥棉。
- V-1: 對樣品進行兩次 10秒的燃燒測試後, 火焰在 30秒內熄滅, 不能引燃 30cm下方的藥棉。
- V-0: 對樣品進行兩次 10秒的燃燒測試後, 火焰在 10秒內熄滅, 不能有燃燒物掉下。



Plastic flame retardant grades are gradually increased from HB, V-2, V-1 to V-0.

HB: The lowest flame retardant grade in the UL94 standard, Require for 3 to 13mm thick samples with a burning rate of less than 40 mm per minute; less than 3 mm thick samples with a burning rate of less than 70 mm per minute; or stop at 100 mm sign.

V-2: After two 10-second burn tests on the sample, the

flame stops at 30 seconds, would ignite cotton wool below 30cm.

V-1: After two 10-second fire tests on the sample, the flame was at 30 seconds Inside goes out. Would not ignite cotton wool below 30cm.

V-0: After two 10-second burn tests on the sample, the flame stops at 10 seconds. No burning substances should fall off.

Wiring Diagram 接線方案

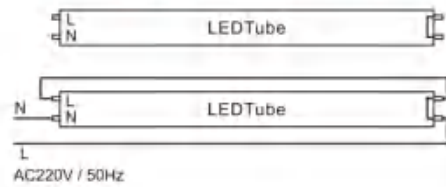

• 新支架內之接線圖

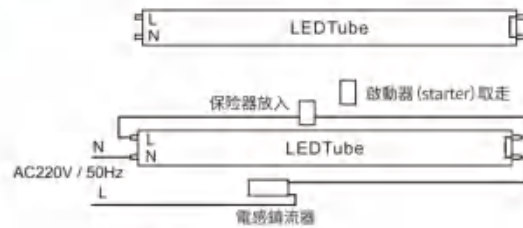

- 舊支架內之接線圖
- 把T8螢光直管及啟動器 (starter) 取走, 更換單端 TBLED直管電感鎮流器, 之後放入保險器, 不需要任何線路上改動。

Glare 眩光

是指視野中由於不適宜亮度分佈, 是因視野內的亮度大幅超過眼睛所適應, 以致引起視覺不舒適和降低物體可見度的視覺條件。視野內產生人眼無法適應之光亮感覺, 可能引起厭惡、煩擾、不舒服或視力受損不舒服、甚或喪失明視度。在視野中某一局部地方出現過高的亮度或前後發生過大的亮度變化。

眩光是引起視覺疲勞的重要原因之一。

Refers to the unsuitable brightness distribution in the visual field, resulting in visual discomfort and reduced object visibility Visual conditions. There is a discomfort feeling in the eye vision that a person cannot withstand that would cause disgust, discomfort or even loss of vision. Excessive brightness in a special location of vision, or excessive brightness changes.

Glare is one of the important causes of visual fatigue.



Power Factor 功率因數

功率因數 (簡稱PF), 是一負載所消耗的有功功率與其視在功率的比值, 純電阻負載的視在功率等於有功功率, 其功率因數為1。若是由電感、電容及電阻組成的負載, 功率因數會小於1。

功率因數在一定程度上反映了發電機容量得以利用的比例, 是合理用電的重要指標。功率因數的高低, 對於電氣設備的利用率和分析、研究電能消耗等問題都有十分重要的意義。電力公司為了反映較大容量設備及浪費能量的成本, 一般會對功率因數較低的工商業用戶以較高的電費費率來計算電費。

Power factor (referred to as PF), is a load consumed by the active power and its apparent power ratio, pure resistance load apparent power is equal to the active power, its power factor is 1. If the load is composed of inductance, capacitance and resistance, the power factor will be less than 1.

Power factor to a certain extent reflects the proportion of generator capacity to be utilized, is an important indicator of rational use of electricity. The level of power factor, for the utilization of electrical

Minimum Allowable Power Factor For LED Lamp With Integrated Driver

Rated Lamp Wattage(LW)	minimum allowable power factor
LW ≤ 5W	0.5
5W < LW ≤ 25W	0.7
LW > 25W	0.9

Information refer to Hong Kong Voluntary Energy Efficiency Labelling for LED lamp January 2017 EMSD (Electrical and Mechanical Services Department)

equipment and analysis, research and power consumption and other issues are of great significance. In order to reflect the cost of larger capacity equipment and wasted energy, the power company will generally lower power factor of industrial and commercial users to higher rates to calculate the electricity bill. Translated with DeepL.com (free version)

Stroboscopic Suppression 頻閃抑制

理想的光源亮度是鎮流後之直流電壓恆定不變的, 這就是理論上的絕對無頻閃。實際上我們平常使用的燈具直流電壓都不會真正的恆定不變, 週期的亮度高低變化程度就是頻率。

市面常見LED驅動電路, 頻閃深度最大的頻率一般都是 100HZ左右。因為PWM高頻是調製在50HZ整流後的電壓

上。實際燈具中, 任何的頻率上都會有一定的頻閃深度 (最亮的亮度和最暗的亮度之差)。那麼, 這裡就存在一個頻閃深度最大的時候所對應的頻閃頻率。還有就是最大的頻閃深度值。頻閃頻率越高對人的影響越小, 頻閃深度越小對人的影響越小, 總體來說頻閃深度越小對人降低或消除導致視力疲勞的低頻率光, 減輕眼睛負擔, 關愛眼睛。

Ideal light source brightness is constant, which is absolute no stroboscopic depth. In fact, the brightness of the lamps we usually install will not be truly stable. The degree of change in the brightness within the period is the frequency.

The common LED drive circuit in the market has the stroboscopic depth at frequency 100 HZ or so. This is because PWM high frequency is modulated on the voltage after 50 HZ rectification. In actual lamps, there will be a certain stroboscopic depth at any frequency. (The difference between the greatest brightest and smallest brightness). Well, there would be the strobe frequency corresponding to the maximum stroboscopic depth, that has the biggest strobe depth value.

The higher the strobe frequency, the smaller the impact is on peoples. As a consulsion, the lower the stroboscopic depth can reduce or eliminate low-frequency light vision fatigue that reduces the burden on the eyes and cares about eye health.



Light source efficiency lm/w (lumen efficiency) 光源效率 lm/w (流明效率)

光源的效率取決於其所發出的光的流明除以起耗電量所得值LED光亮度, 並非似功耗(W)度量, 而是以流明輸出(lm)來決定。

iLighting LED 流明效益高, 更有歐洲A級能源標籤, 保證節電環保。

The efficiency of a light source depends on the lumen of the light it emits divided by the power consumption LED brightness is not similar to wattage (W) measurement, but measured in lumens output (lm) Decide.

iLighting LED Lumen has high lumen efficiency, and it also has obtained European A energy label to ensure power saving and environmental protection.

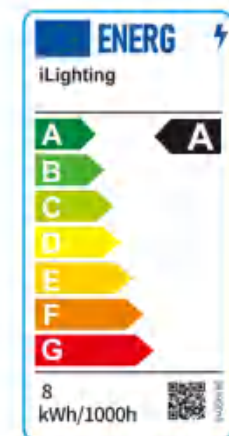

Control Panel

Series Type: CP-YF

Features 產品特點 >>

- Power load 40-300W
- Small size and easy to install
- High stability
- Easy to connect
- Used in LED products, light strips, wardrobes, cabinet lights, various electrical appliances

- 功率負載40-300W
- 體積小易於安裝
- 高穩定性
- 易於連接
- 应用于LED產品、燈帶、衣櫃、櫥櫃燈、各種電器

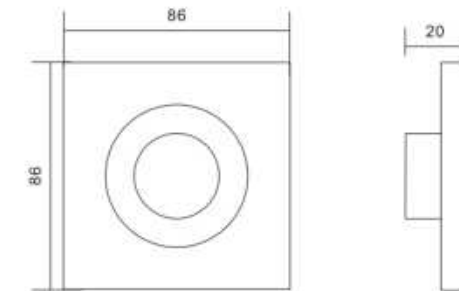

Unit : mm

Specification 產品規格 >>

Model 型號	Voltage 電壓	Load Power 負載功率	Switch Type 開關類型	Operating Temperature 工作溫度	Dimension 尺寸	Weight 重量
	(V)	(W)		(°C)	(mm)	(g)
CP-YF-86	220	40-300	Knob Type	-20~+50	86*86*20	200

- Product specifications, some can be customized according to customer needs
- This type of certification is issued by the laboratory for safety certification, fire testing, environmental protection materials (RoHS), photobiological safety for Exemption Group and other tests to ensure that customers are more comfortable and satisfied.

- 產品規格參數,部分可根據客戶需求定制
- 此型號認證由可實驗室發出之安全認證消防測試,環保物料(RoHS),光生物安全為Exemption Group及其它測試,保證客戶使用更安心滿意

Control Panel

控制面板



Control Panel

Series Type: CP-TE

Features 產品特點 >>

- Material: PC flame retardant
- Power load □300W
- Small size and easy to install
- High stability
- Easy to connect
- Used in homes, clubs, hotels, offices, etc

- 材質:PC阻燃劑
- 功率負載≤300W
- 體積小易於安裝
- 高穩定性
- 易於連接
- 应用于居家、會所、酒店、辦公等

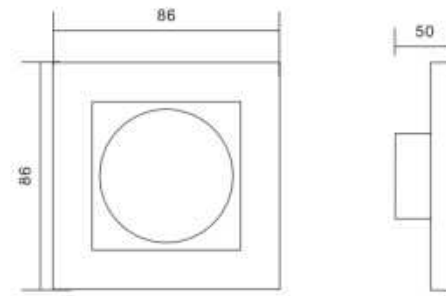

Unit : mm

Specification 產品規格 >>

Model 型號	Voltage 電壓 (V)	Load Power 負載功率 (W)	Switch Type 開關類型	Operating Temperature 工作溫度 (°C)	Dimension 尺寸 (mm)	Weight 重量 (g)
CP-TE-86	220	≤300	Knob Type	-20~+50	86*86*50	220

- Product specifications, some can be customized according to customer needs
- This type of certification is issued by the laboratory for safety certification, fire testing, environmental protection materials (RoHS), photobiological safety for Exemption Group and other tests to ensure that customers are more comfortable and satisfied.

- 產品規格參數,部分可根據客戶需求定制
- 此型號認證由可實驗室發出之安全認證消防測試,環保物料(RoHS),光生物安全為Exemption Group及其它測試,保證客戶使用更安心滿意

Control Panel

Series Type: CP-D

Features 產品特點 >>

- Power load 96W / 192W
- Small size and easy to install
- High stability
- Easy to connect
- Used in LED products, light strips, wardrobes, cabinet lights, various electrical appliances

- 功率負載96W / 192W
- 體積小易於安裝
- 高穩定性
- 易於連接
- 应用于LED產品、燈帶、衣櫃、櫥櫃燈、各種電器

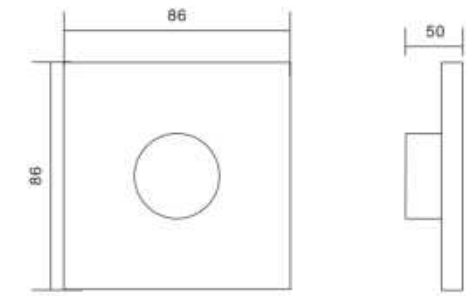

Unit : mm

Specification 產品規格 >>

Model 型號	DC Voltage 電壓 (V)	Power 功率 (W)	Output 輸出電流 (A)	Operating Temperature 工作溫度 (°C)	Dimension 尺寸 (mm)	Weight 重量 (g)
CP-D62-96	12	96	4	-20~+50	86*86*50	220
CP-D62-192	24	192	4	-20~+50	86*86*50	220

- Product specifications, some can be customized according to customer needs
- This type of certification is issued by the laboratory for safety certification, fire testing, environmental protection materials (RoHS), photobiological safety for Exemption Group and other tests to ensure that customers are more comfortable and satisfied.

- 產品規格參數,部分可根據客戶需求定制
- 此型號認證由可實驗室發出之安全認證消防測試,環保物料(RoHS),光生物安全為Exemption Group及其它測試,保證客戶使用更安心滿意

0-10V Dimming LED Driver

Series Type: DC-010

Features 產品特點 >>

- Control mode:0-10V
- Compliant with Safety Extra Low Voltage Standard
- Short circuit/over-temperature/over load/over voltage Protection
- Dimming range from 0-100%
- Flicker free
- 控制方式:0-10V
- 符合安全特低電壓標準
- 短路/過熱/過載/過壓保護
- 調光範圍為0-100%
- 無閃爍



Unit : mm

Specification 產品規格 >>

Model 型號	Input Voltage 輸入電壓 (V)	Output Voltage 輸出電壓 (V)	Wattage 功率 (W)	Life 壽命 (Hrs)	Max operating temperature 最高工作溫度 (°C)	Ambient temperature 環境溫度 (°C)	Standard size 標準尺寸 (mm)	PCS/CTN 每箱數量 (pcs)
DC-9W-010	100-240	30~42	9	50000	45	-20~45	243*30*21	25
DC-18W-010	100-240	30~42	18	50000	45	-20~45	243*30*21	25
DC-26W-010	100-240	30~42	26	50000	45	-20~45	243*30*21	25
DC-32W-010	100-240	30~42	32	50000	45	-20~45	243*30*21	25

- Product specifications, some can be customized according to customer needs
- This type of certification is issued by the laboratory for safety certification, fire testing, environmental protection materials (RoHS), photobiological safety for Exemption Group and other tests to ensure that customers are more comfortable and satisfied.

- 產品規格參數,部分可根據客戶需求定制
- 此型號認證由可實驗室發出之安全認證消防測試,環保物料(RoHS),光生物安全為Exemption Group及其它測試,保證客戶使用更安心滿意

LED Driver

LED驅動

TRIAE Dimming LED Driver

Series Type: DC-LT-TR

Features 產品特點 >>

- Dimming interface : TRIAC
- Constant current output, parameters can be customized to 8W to 16.5W (or Up)
- Class 2 LED power supply, Double-isolated
- Short circuit, over current and over voltage protection. Efficiency up to 87%
- Compatible with many kinds of dimming system, such as Philips, Osram, Tridonic, Siemens, Lutron, KNX etc
- 調光接口: TRIAC
- 恆流輸出, 參數可定制為8W至16.5W (或更高)
- 2級LED電源, 雙隔離
- 短路, 過流, 過壓保護, 效率高達87%
- 與飛利浦, 歐司朗, 銳高, 西門子, 路創, KNX等多種調光系統兼容

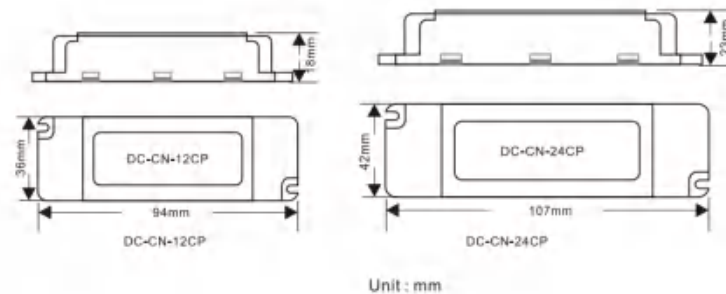

Specification 產品規格 >>

Model 型號	Input Voltage 輸入電壓 (V)	Output Voltage 輸出電壓 (V)	Wattage 功率 (W)	Life 壽命 (Hrs)	Max operating temperature 最高工作溫度 (°C)	Ambient temperature 環境溫度 (°C)	Standard size 標準尺寸 (mm)	PCS/CTN 每箱數量 (pcs)
DC-LT20-TR	220-240	30~42	9	50000	45	-20~45	94*36*18	25
DC-LT40-TR	220-240	30~42	18	50000	45	-20~45	107*42*23	25

- Product specifications, some can be customized according to customer needs
- This type of certification is issued by the laboratory for safety certification, fire testing, environmental protection materials (RoHS), photobiological safety for Exemption Group and other tests to ensure that customers are more comfortable and satisfied.
- 產品規格參數, 部分可根據客戶需求定制
- 此型號認證由可實驗室發出之安全認證消防測試, 環保物料 (RoHS), 光生物安全為Exemption Group及其它測試, 保證客戶使用更安心滿意

DALI Dimming LED Driver

Series Type: DC-LT-DA

Features 產品特點 >>

- Control mode: DALI
- Compliant with Safety Extra Low Voltage Standard
- Short circuit/over-temperature/over load/over voltage Protection / Flicker free
- Dimming range from 0-100%
- Compatible with many kinds of dimming system, such as Philips, Osram, Tridonic, Siemens, Lutron, KNX etc
- 控制方式: DALI
- 符合安全特低電壓標準
- 短路/過熱/過載/過壓保護/無閃爍
- 調光範圍為0-100%
- 與飛利浦, 歐司朗, 銳高, 西門子, 路創, KNX等多種調光系統兼容

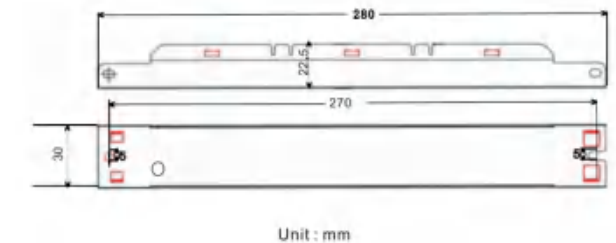

Specification 產品規格 >>

Model 型號	Input Voltage 輸入電壓 (V)	Output Voltage 輸出電壓 (V)	Wattage 功率 (W)	Life 壽命 (Hrs)	Max operating temperature 最高工作溫度 (°C)	Ambient temperature 環境溫度 (°C)	Standard size 標準尺寸 (mm)	PCS/CTN 每箱數量 (pcs)
DC-LT20-DA	100~240	30~42	9	50000	45	-20~45	280*30*22.5	25
DC-LT40-DA	100~240	30~42	18	50000	45	-20~45	280*30*22.5	25
DC-LT20-2-DA	100~240	30~42	2*9	50000	45	-20~45	280*30*22.5	25
DC-LT40-2-DA	100~240	30~42	2*18	50000	45	-20~45	280*30*22.5	25

- Product specifications, some can be customized according to customer needs
- This type of certification is issued by the laboratory for safety certification, fire testing, environmental protection materials (RoHS), photobiological safety for Exemption Group and other tests to ensure that customers are more comfortable and satisfied.
- 產品規格參數, 部分可根據客戶需求定制
- 此型號認證由可實驗室發出之安全認證消防測試, 環保物料 (RoHS), 光生物安全為Exemption Group及其它測試, 保證客戶使用更安心滿意

LED External Driver

Series Type: LD-LT

Features 產品特點 >>

- Compliant with Safety Extra Low Voltage Standard
- Short circuit/over-temperature/over load /over voltage Protection Non-dimmable external driver
- Flicker free
- Low THD < 10%
- 符合安全特低電壓標準
- 短路/過熱/超載/過壓保護不可調光外部驅動器
- 無閃爍
- 低THD<10%

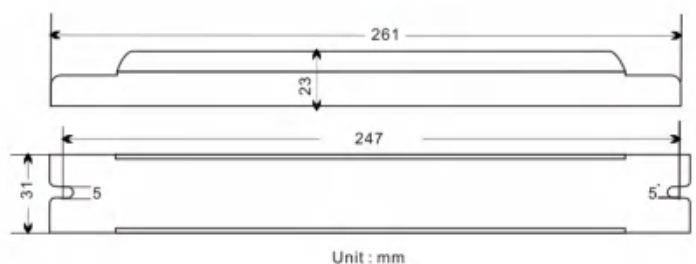

Specification 產品規格 >>

Model 型號	Input Voltage 輸入電壓 (V)	Output Voltage 輸出電壓 (V)	Wattage 功率 (W)	Life 壽命 (Hrs)	Max operating temperature 最高工作溫度 (°C)	Ambient temperature 環境溫度 (°C)	Standard size 標準尺寸 (mm)	PCS/CTN 每箱數量 (pcs)
LD-LT20	100~240	30~42	9	50000	45	-20~45	261*31*23	25
LD-LT40	100~240	30~42	18	50000	45	-20~45	261*31*23	25
LD-LT20-2	100~240	30~42	2*9	50000	45	-20~45	261*31*23	25
LD-LT40-2	100~240	30~42	2*18	50000	45	-20~45	261*31*23	25

- Product specifications, some can be customized according to customer needs
- This type of certification is issued by the laboratory for safety certification, fire testing, environmental protection materials (RoHS), photobiological safety for Exemption Group and other tests to ensure that customers are more comfortable and satisfied.
- 產品規格參數,部分可根據客戶需求定制
- 此型號認證由可實驗室發出之安全認證消防測試,環保物料 (RoHS), 光生物安全為Exemption Group及其它測試,保證客戶使用更安心滿意

Switch Series

開關系列

Hand-sweep Infrared Sensor Switch

Series Type: TS-L201

Features 產品特點 >>

- Infrared sensor to detect hand movement at 8 cm distance
 - Sensor probe separate from controller
 - Flexible to install the probe in the side, top or front cabinet
 - Controller & cables to be installed inside cabinet
 - Easily connect to junction box by plug
- 紅外傳感器可檢測手在8厘米距離處的移動
 - 傳感器探頭與控制器分離
 - 可以靈活地將探頭安裝在側面, 頂部或前面的櫃中
 - 控制器和電纜要安裝在櫃內
 - 通過插頭輕鬆連接到接線盒

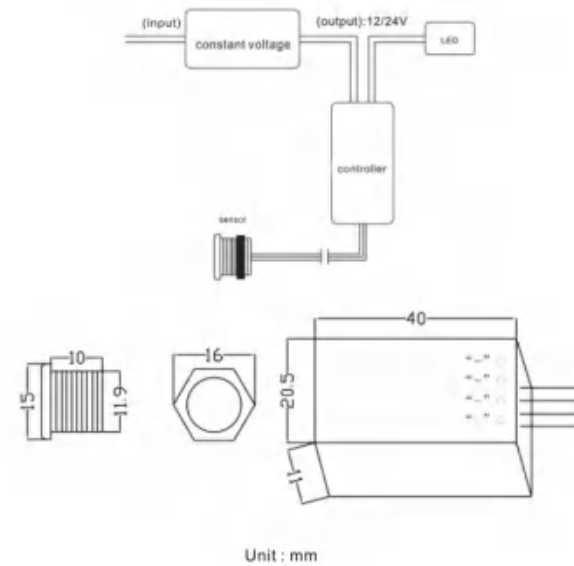

Specification 產品規格 >>

Model 型號	DC Voltage 電壓 (V)	Wattage 功率 (W)	Driver Size 驅動器尺寸 (mm)	Switch Size 開關尺寸 (mm)	Life 壽命 (Hrs)	Operation Temperature 工作溫度 (°C)
TS-L201	12	max 30	40*20.5*11	15*10	50000	-20~50
TS-L201	24	max 60	40*20.5*11	15*10	50000	-20~50

- Product specifications, some can be customized according to customer needs
 - This type of certification is issued by the laboratory for safety certification, fire testing, environmental protection materials (RoHS), photobiological safety for Exemption Group and other tests to ensure that customers are more comfortable and satisfied.
- 產品規格參數, 部分可根據客戶需求定制
 - 此型號認證由可實驗室發出之安全認證消防測試, 環保物料 (RoHS), 光生物安全為Exemption Group及其它測試, 保證客戶使用更安心滿意

LED ON/OFF Toggle Switch

Series Type: TS-L106A

Features 產品特點 >>

- Round Toggle on/off switch
 - Available in black or off white color
 - Suitable to install and match most decor
- 圓形撥動開關
 - 黑色或灰白色可選
 - 適合安裝和匹配大多數裝飾

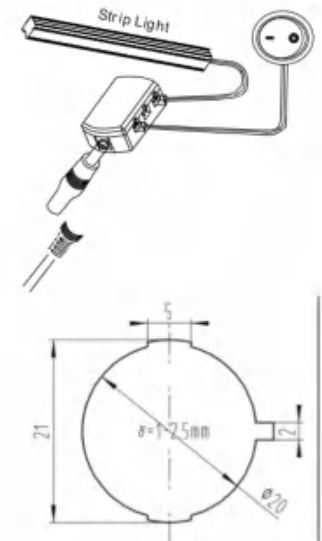
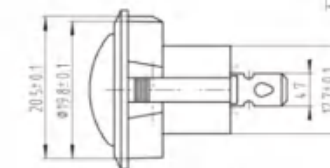
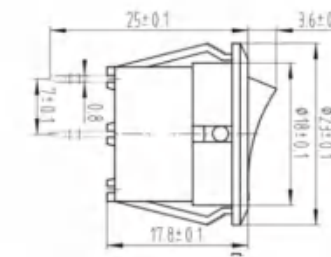

Unit : mm

Specification 產品規格 >>

Model 型號	DC Voltage 電壓 (V)	Standard Size 標準尺寸 (mm)	Hole Diameter 孔徑 (mm)	Button Diameter 按鈕直徑 (mm)	Life 壽命 (cycles)	Operation Temperature 工作溫度 (°C)
TS-L106A	12	23*28.6	20	23	>10000	0~85
TS-L106A	24	23*28.6	20	23	>10000	0~85

- Product specifications, some can be customized according to customer needs
 - This type of certification is issued by the laboratory for safety certification, fire testing, environmental protection materials (RoHS), photobiological safety for Exemption Group and other tests to ensure that customers are more comfortable and satisfied.
- 產品規格參數, 部分可根據客戶需求定制
 - 此型號認證由可實驗室發出之安全認證消防測試, 環保物料 (RoHS), 光生物安全為Exemption Group及其它測試, 保證客戶使用更安心滿意

LED PIR Sensor Switch

Series Type: MS-PIR

Features 產品特點 >>

- Passive Infrared sensor to detect body movement
- Flexible to install the sensor next to light strip
- Detection distance 3-5 Meter
- Easily connect to junction box by plug
- Fully automatic induction: automatically turn on the light after sensing a person, the light is on when the person is on, and the light is off when the person is walking, no video flickering, safe power saving
- 被動紅外傳感器可防止身體移動
- 可以靈活地將傳感器安裝在燈帶旁邊
- 檢測距離3-5米
- 通過插頭輕鬆連接到接線盒
- 全自動感應: 感應到人後自動開燈, 人在燈亮, 人走燈滅, 無可視頻閃、安全節電, 不受聲、物等外界因素干擾

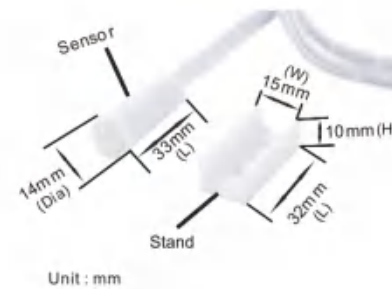
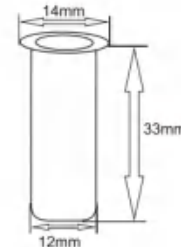
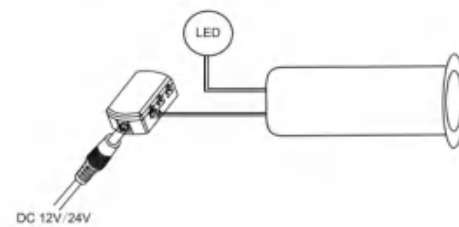

Specification 產品規格 >>

Model 型號	DC Voltage 電壓 (V)	Wattage 功率 (W)	Standard Size 標準尺寸 (mm)	Detection Distance 檢測距離 (cm)	Life 壽命 (Hrs)	Operation Temperature 工作溫度 (°C)
MS-PIR-DC24V	12	max 36	30*14	3-5	50000	-20~75
MS-PIR-DC24V	24	max 72	30*14	3-5	50000	-20~75

- Product specifications, some can be customized according to customer needs
- This type of certification is issued by the laboratory for safety certification, fire testing, environmental protection materials (RoHS), photobiological safety for Exemption Group and other tests to ensure that customers are more comfortable and satisfied.
- 產品規格參數, 部分可根據客戶需求定制
- 此型號認證由可實驗室發出之安全認證消防測試, 環保物料 (RoHS), 光生物安全為Exemption Group及其它測試, 保證客戶使用更安心滿意

Dimming Touch Switch

Series Type: SW-BL

Features 產品特點 >>

- Round Toggle on/off switch
- Available in black or off white color
- Suitable to install and match most decor
- 圓形撥動開關
- 黑色或灰白色可選
- 適合安裝和匹配大多數裝飾

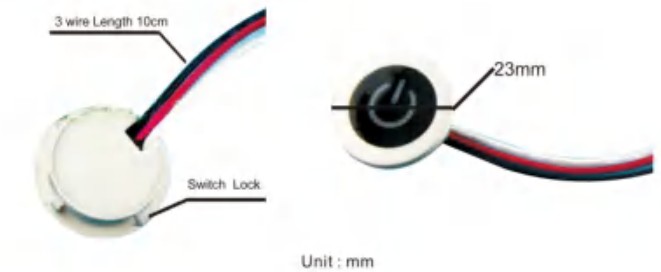

Specification 產品規格 >>

Model 型號	DC Voltage 電壓 (V)	Standard Size 標準尺寸 (mm)	Hole Diameter 孔徑 (mm)	Switch Height 開關高度 (mm)	Life 壽命 (cycles)	Operation Temperature 工作溫度 (°C)
SW-T12-3DM-BL	12-24	21.5 - 22	23	9.9	>10000	0~85

- Product specifications, some can be customized according to customer needs
- This type of certification is issued by the laboratory for safety certification, fire testing, environmental protection materials (RoHS), photobiological safety for Exemption Group and other tests to ensure that customers are more comfortable and satisfied.
- 產品規格參數, 部分可根據客戶需求定制
- 此型號認證由可實驗室發出之安全認證消防測試, 環保物料 (RoHS), 光生物安全為Exemption Group及其它測試, 保證客戶使用更安心滿意

Hand-sweep Infrared Sensor Switch

Series Type: TS-H201



Model 型號	DC Voltage 電壓 (V)	Wattage 功率 (W)	Driver Size 驅動器尺寸 (mm)	Switch Size 開關尺寸 (mm)	Life 壽命 (Hrs.)	Operation Temperature 工作溫度 (°C)
TS-H201	12	max 30	100*43*21	≤ 15	50000	-20~75
TS-H201	24	max 60	100*43*21	≤ 15	50000	-20~75

Series Type: TS-L301



Model 型號	DC Voltage 電壓 (V)	Wattage 功率 (W)	Driver Size 驅動器尺寸 (mm)	Switch Size 開關尺寸 (mm)	Life 壽命 (Hrs.)	Operation Temperature 工作溫度 (°C)
TS-L301	12	max 30	83*35.5*18.5	22.5*14.5	50000	-20~50
TS-L301	24	max 60	83*35.5*18.5	22.5*14.5	50000	-20~50

Series Type: TS-9019



Model 型號	DC Voltage 電壓 (V)	Wattage 功率 (W)	Driver Size 驅動器尺寸 (mm)	Switch Size 開關尺寸 (mm)	Life 壽命 (Hrs.)	Operation Temperature 工作溫度 (°C)
TS-9019	12	max 30	74*10*7.5	8	50000	-20~50
TS-9019	24	max 60	74*10*7.5	8	50000	-20~50

Series Type: TS-L501



Model 型號	DC Voltage 電壓 (V)	Wattage 功率 (W)	Driver Size 驅動器尺寸 (mm)	Switch Size 開關尺寸 (mm)	Life 壽命 (Hrs.)	Operation Temperature 工作溫度 (°C)
TS-L501	12	max 30	28*14*6.9	10*10	50000	-20~50
TS-L501	24	max 60	28*14*6.9	10*10	50000	-20~50

Infrared sensor switch

Series Type: TS-SHID20



Model 型號	DC Voltage 電壓 (V)	Wattage 功率 (W)	Controller Size 控制器尺寸 (mm)	Sensor Probe 傳感器探頭 (mm)	Life 壽命 (Hrs.)	Operation Temperature 工作溫度 (°C)
TS-SHID20	12	max 30	40*20*11	16	50000	-20~50
TS-SHID20	24	max 60	40*20*11	16	50000	-20~50

Tact switch

Series Type: TS-L1400



Model 型號	DC Voltage 電壓 (V)	Wattage 功率 (W)	Standard Size 標準尺寸 (mm)	Induction Distance 感應距離 (cm)	Life 壽命 (Hrs.)	Operation Temperature 工作溫度 (°C)
TS-L1400	12	max 30	19*10	8	50000	-20~50
TS-L1400	24	max 60	19*10	8	50000	-20~50

Magnetic Reed Switch (Rectangular Shape)

Series Type: TS-L086



Model 型號	DC Voltage 電壓 (V)	Standard Size 標準尺寸 (mm)	Controller Size 控制器尺寸 (mm)	Sensing distance 感應距離 (mm)	Life 壽命 (cycles)	Operation Temperature 工作溫度 (°C)
TS-L086	12	28*19*7	6*3	10	>10000	-40~75
TS-L086	24	28*19*7	6*3	10	>10000	-40~75

Magnetic reed switch (Cylinder shape)

Series Type: TS-L048



Model 型號	DC Voltage 電壓 (V)	Standard Size 標準尺寸 (mm)	Controller Size 控制器尺寸 (mm)	Sensing distance 感應距離 (mm)	Life 壽命 (cycles)	Operation Temperature 工作溫度 (°C)
TS-L048	12	33*10	17*10	10	>10000	0~75
TS-L048	24	33*10	17*10	10	>10000	0~75

- Product specifications, some can be customized according to customer needs
- This type of certification is issued by the laboratory for safety certification, fire testing, environmental protection materials (RoHS), photobiological safety for Exemption Group and other tests to ensure that customers are more comfortable and satisfied.

- 產品規格參數,部分可根據客戶需求定制
- 此型號認證由可實驗室發出之安全認證消防測試,環保物料(RoHS),光生物安全為Exemption Group及其它測試,保證客戶使用更安心滿意

- Product specifications, some can be customized according to customer needs
- This type of certification is issued by the laboratory for safety certification, fire testing, environmental protection materials (RoHS), photobiological safety for Exemption Group and other tests to ensure that customers are more comfortable and satisfied.

- 產品規格參數,部分可根據客戶需求定制
- 此型號認證由可實驗室發出之安全認證消防測試,環保物料(RoHS),光生物安全為Exemption Group及其它測試,保證客戶使用更安心滿意