



| EASTLIKE LED Co., Ltd

# CATALOG

## LED Lighting Series

Green    Low Carbon    Energy Saving

### 1. LED Tube

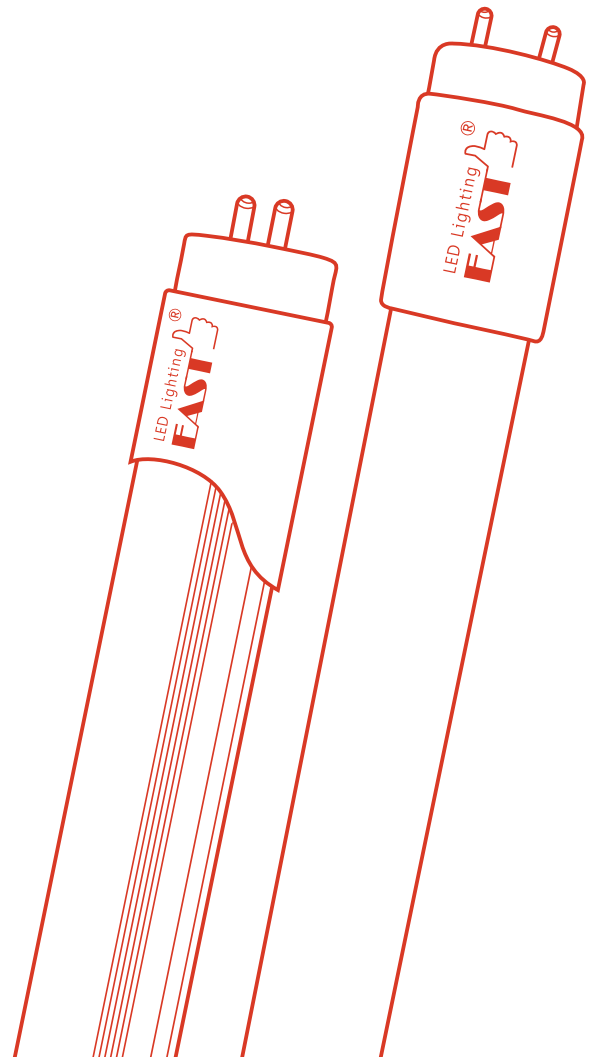

[www.eastlike.com](http://www.eastlike.com)



# 公司簡介 Company Profile

LED Lighting

EAST

LED Lighting®  
EAST



製造和營銷綠色低碳節能照明產品

Manufacturing And Marketing Green Low Carbon  
And Energy Saving Lighting Products

## EASTLIKE LED COMPANY 東 欖 照 明 公 司

EASTLIKE LED Co., Ltd • emerges as a lighting designer manufacturer and supplier established in Hong Kong and Mainland China .

The company devotes herself in the development, manufacturing and marketing of green, low-carbon and energy-saving lighting products. we are proud to provide a wide range of LED products

東欖LED照明公司 • 您的照明設計師。

我們作為製造商和供應服務於香港和中國大陸。公司致力於開發，製造和行銷綠色，低碳和節能照明產品。

我們竭誠為您服務，為您提供種類繁多的LED產品。

# 目录

# Content

LED Lighting

EAST

®



# Commercial LED T8 Tube

Series Type: L

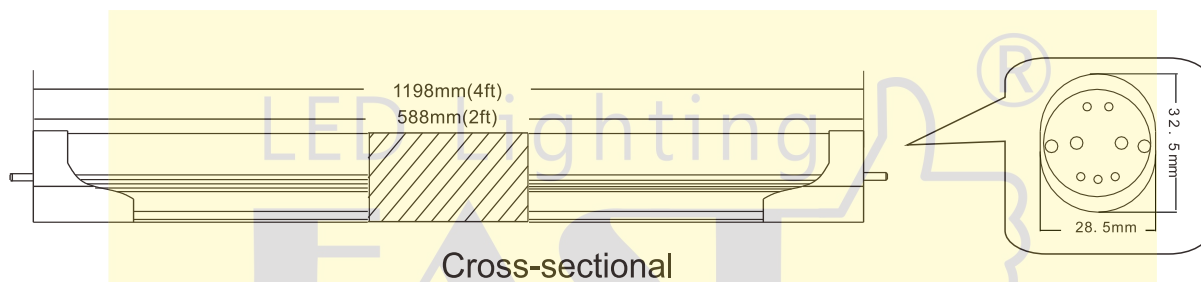

## Features 產品特點

- ★ Uniform light emission
- ★ SPM Design – power circuit protection to cut off individual LEDs when mal-functioned
- ★ Optional: rotary end knob for angle adjustment

- ★ 發光均勻
- ★ SPM設計-電源電路保護，當個別led故障時切斷單個
- ★ LED電路  
可選配：角度調節旋鈕

## Specification 產品規格

Model 型號	Voltage 電壓 (V)	Wattage 功率 (W)	Length 長度 (mm)	Lamp Life 光度壽命 (Hrs)	Colour Temp 色溫 (K)	Lumen Output 輸出流明 (Lm/W)	Color Rendering 顯色度 (CRI)	Lamp Base 燈腳	PCS/CTN 每箱數量 (pcs)
EL-I1218-L128A4	100~240	18	1200	20,000	4000	120	>80	T8,G13	25
EL-I1218-L128A6	100~240	18	1200	20,000	6000	120	>80	T8,G13	25
EL-I0609-L128A4	100~240	9	600	20,000	4000	120	>80	T8,G13	25
EL-I0609-L128A6	100~240	9	600	20,000	6000	120	>80	T8,G13	25

Light efficiency (lm/W), Power (W), Color Rendering Index (CRI), Can be customized according to customer needs.

Our Standard Power factor (PF) > 0.9 and Total harmonic index THD < 15%, According to customer requirements can produce a lower THD < 10%.

This type of certification is issued by a government-approved laboratory for Safety certification, Fire testing, Restriction of Hazardous Substances (RoHS), Photobiological safety of lamps and lamp systems. (an Exemption Group) and other test certifications to ensure product quality.

光效 (lm/W)、功率 (W)、顯色指數 (CRI)，可根據客戶需求定制。

此型號標準之功率因素 (PF) > 0.9，總諧波指數 THD < 15%，可按客戶需要生產低總諧波指數 < 10%。

此型號認證由可實驗室發出之安全認證消防測試，環保物料 (RoHS)，光生物安全為 Exemption Group 及其它測試，保證客戶使用更安心滿意。

# LED T5 Tube

Series Type: N

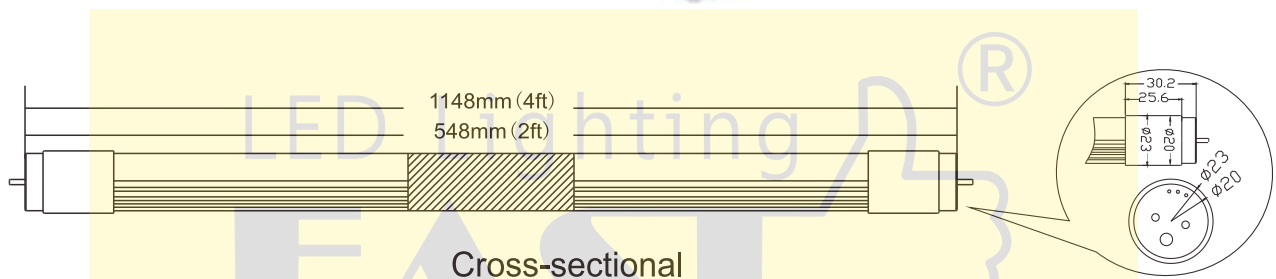

## Features 產品特點

- |  |   |
|--|---|
| <ul style="list-style-type: none"> <li>★ Uniform illumination</li> <li>★ Modification of existing T5 lamps</li> <li>★ SPM design - cut off power circuit protection</li> <li>★ T6 tube body achieves the best lighting effect</li> <li>★ Emergency options available: compatible with most emergency battery brands and in accordance with FSD regulation ppa104 part a11</li> </ul> | <ul style="list-style-type: none"> <li>★ 均勻發光</li> <li>★ 對現有T5燈進行改造</li> <li>★ SPM設計-切斷電源電路保護</li> <li>★ T6管體達到最佳照明效果</li> <li>★ 可提供應急選項：與大多數應急電池品牌相容，並符合FSD法規PPA104第A11部分</li> </ul> |
|--|---|

## Specification 產品規格

Model 型號	Voltage 電壓	Wattage 功率	Length 長度	Lamp Life 光度壽命	Colour Temp 色溫	Lumen Output 輸出流明	Color Rendering 顯色度	Lamp Base 燈腳	PCS/CTN 每箱數量
	(V)	(W)	(mm)	(Hrs)	(K)	(Lm/W)	(CRI)		(pcs)
EL-I51216-N128A4	100~240	16	1200	20,000	4000	120	>80	T5,G5	50
EL-I51216-N128A6	100~240	16	1200	20,000	6000	120	>80	T5,G5	50
EL-I50608-N128A4	100~240	8	600	20,000	4000	100	>80	T5,G5	50
EL-I50608-N128A6	100~240	8	600	20,000	6000	100	>80	T5,G5	50

Light efficiency (lm/W), Power (W), Color Rendering Index (CRI), Can be customized according to customer needs.

Our Standard Power factor (PF) > 0.9 and Total harmonic index THD < 15%, According to customer requirements can produce a lower THD < 10%.

This type of certification is issued by a government-approved laboratory for Safety certification, Fire testing, Restriction of Hazardous Substances (RoHS), Photobiological safety of lamps and lamp systems. (an Exemption Group) and other test certifications to ensure product quality.

光效 (lm/W)、功率 (W)、顯色指數 (CRI)，可根據客戶需求定制。

此型號標準之功率因素 (PF) > 0.9，總諧波指數 THD < 15%，可按客戶需要生產低總諧波指數 < 10%。

此型號認證由可實驗室發出之安全認證消防測試，環保物料 (RoHS)，光生物安全為 Exemption Group 及其它測試，保證客戶使用更安心滿意。

# Glass LED T8 Tube

Series Type: G

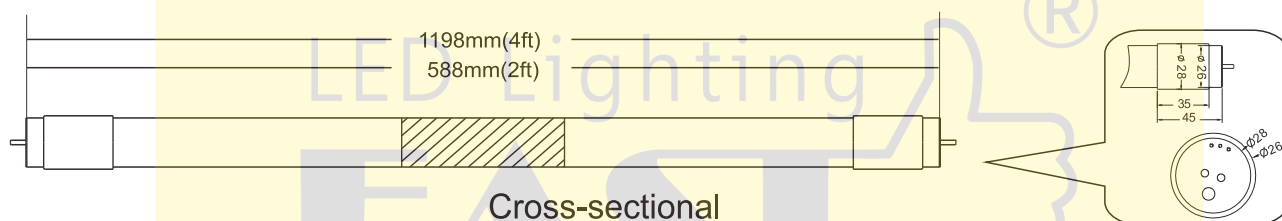
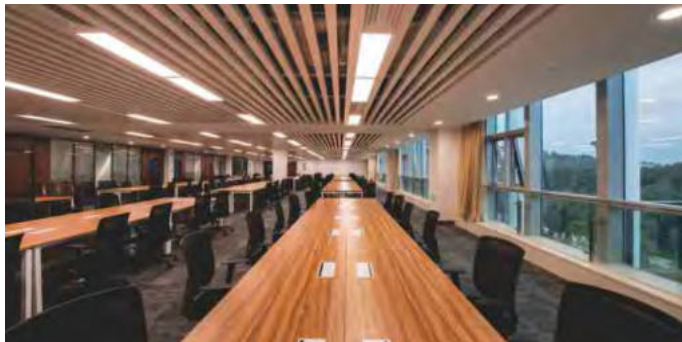

## Features 產品特點

- ★ Uniform light emission
- ★ SPM design - power circuit protection, which cuts off a single LED circuit in case of individual led failure
- ★ Optional: angle adjustment knob
- ★ 發光均勻
- ★ 高光輸出和低功耗
- ★ 對現有T8燈進行改造
- ★ SPM設計即電源電路保護，在故障時可立即切斷單個LED電路
- ★ 光束角度：300度

## Specification 產品規格

Model 型號	Voltage 電壓 (V)	Wattage 功率 (W)	Length 長度 (mm)	Lamp Life 光度壽命 (Hrs)	Colour Temp 色溫 (K)	Lumen Output 輸出流明 (Lm/W)	Color Rendering 顯色度 (CRI)	Lamp Base 燈腳	PCS/CTN 每箱數量 (pcs)
EL-I1218-G128A4	100~240	18	1200	20,000	4000	120	>80	T8,G13	25
EL-I1218-G128A6	100~240	18	1200	20,000	6000	120	>80	T8,G13	25
EL-I0609-G128A4	100~240	9	600	20,000	4000	120	>80	T8,G13	25
EL-I0609-G128A6	100~240	9	600	20,000	6000	120	>80	T8,G13	25

Light efficiency (lm/W), Power (W), Color Rendering Index (CRI), Can be customized according to customer needs.

Our Standard Power factor (PF) > 0.9 and Total harmonic index THD < 15%, According to customer requirements can produce a lower THD < 10%.

This type of certification is issued by a government-approved laboratory for Safety certification, Fire testing, Restriction of Hazardous Substances (RoHS), Photobiological safety of lamps and lamp systems. (an Exemption Group) and other test certifications to ensure product quality.

光效 (lm/W)、功率 (W)、顯色指數 (CRI)，可根據客戶需求定制。

此型號標準之功率因素 (PF) > 0.9，總諧波指數 THD < 15%，可按客戶需要生產低總諧波指數 < 10%。

此型號認證由可實驗室發出之安全認證消防測試，環保物料 (RoHS)，光生物安全為 Exemption Group 及其它測試，保證客戶使用更安心滿意。

## Glass LED T5 Tube

Series Type: I5-G

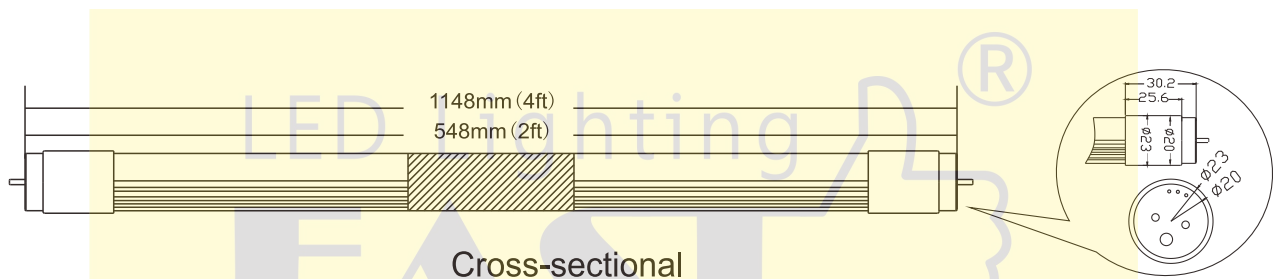

## Features 產品特點

- ★ High power, high luminous efficiency, high efficiency and durability
- ★ Uniform lighting without video flashing
- ★ SPM design - power circuit protection, which cuts off a single LED circuit in case of individual led failure
- ★ Pure heat conductive glass lamp tube does not deteriorate and turn yellow, with high luminous maintenance rate
- ★ Strong compatibility, easy installation and use, and long toxic life
- ★ Commonly used in supermarkets, garages, homes, public rooms, etc

- ★ 大功率，高光效，高效耐用
- ★ 發光均勻，無可視頻閃
- ★ SPM設計-電源電路保護，當個別LED故障時切斷單個LED電路
- ★ 純導熱玻璃燈管不劣化發黃，發光維持率高
- ★ 相容性強，安裝使用方便，壽命超長
- ★ 通用於超市、車庫、家居、辦公室等

## Specification 產品規格

Model 型號	Voltage 電壓 (V)	Wattage 功率 (W)	Length 長度 (mm)	Lamp Life 光度壽命 (Hrs)	Colour Temp 色溫 (K)	Lumen Output 輸出流明 (Lm/W)	Color Rendering 顯色度 (CRI)	Lamp Base 燈腳	PCS/CTN 每箱數量 (pcs)
EL-I51216-G128A4	100~240	16	1200	20,000	4000	140	>80	T5,G5	50
EL-I51216-G128A6	100~240	16	1200	20,000	6000	140	>80	T5,G5	50
EL-I50608-G128A4	100~240	8	600	20,000	4000	140	>80	T5,G5	50
EL-I50608-G128A6	100~240	8	600	20,000	6000	140	>80	T5,G5	50

Light efficiency (lm/W), Power (W), Color Rendering Index (CRI), Can be customized according to customer needs.

Our Standard Power factor (PF) > 0.9 and Total harmonic index THD < 15%, According to customer requirements can produce a lower THD < 10%.

This type of certification is issued by a government-approved laboratory for Safety certification, Fire testing, Restriction of Hazardous Substances (RoHS), Photobiological safety of lamps and lamp systems. (an Exemption Group) and other test certifications to ensure product quality.

光效 (lm/W)、功率 (W)、顯色指數 (CRI)，可根據客戶需求定制。

此型號標準之功率因素 (PF) > 0.9, 總諧波指數 THD < 15%, 可按客戶需要生產低總諧波指數 < 10%。

此型號認證由可實驗室發出之安全認證消防測試, 環保物料 (RoHS), 光生物安全為 Exemption Group 及其它測試, 保證客戶使用更安心滿意。

# High Lumen T8 LED Tube

Series Type: H

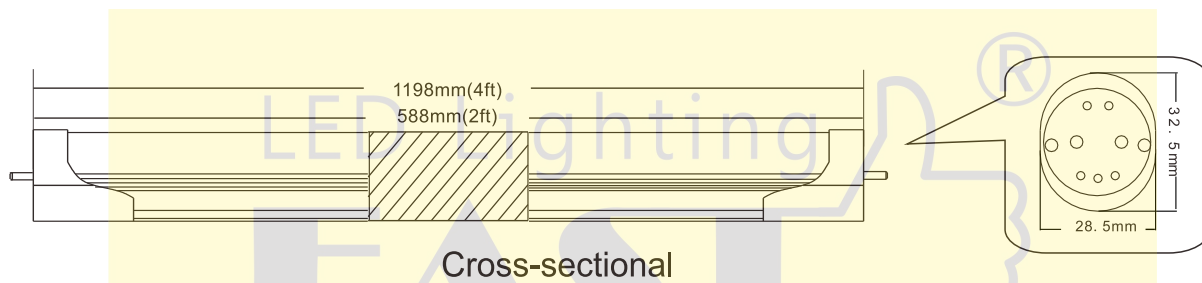

## Features 產品特點

- ★ Uniform light emission
- ★ Modification of existing T8 lamps  
SPM design, namely power circuit protection, can immediately cut off a single LED circuit in case of fault
- ★ T8 tube body can achieve the best lighting effect

- ★ 發光均勻
- ★ 對現有的T8燈進行改造
- ★ SPM設計即電源電路保護，在故障時可立即切斷單個LED電路
- ★ T8管體達到最佳照明效果

## Specification 產品規格

Model 型號	Voltage 電壓 (V)	Wattage 功率 (W)	Length 長度 (mm)	Lamp Life 光度壽命 (Hrs)	Colour Temp 色溫 (K)	Lumen Output 輸出流明 (Lm/W)	Color Rendering 顯色度 (CRI)	Lamp Base 燈腳	PCS/CTN 每箱數量 (pcs)
EL-I1218-H178A4	100~240	18	1200	20,000	4000	170	>80	T8,G13	25
EL-I1218-H178A6	100~240	18	1200	20,000	6000	170	>80	T8,G13	25
EL-I0609-H178A4	100~240	9	600	20,000	4000	170	>80	T8,G13	25
EL-I0609-H178A6	100~240	9	600	20,000	6000	170	>80	T8,G13	25

Light efficiency (lm/W), Power (W), Color Rendering Index (CRI), Can be customized according to customer needs.

Our Standard Power factor (PF) > 0.9 and Total harmonic index THD < 15%, According to customer requirements can produce a lower THD < 10%.

This type of certification is issued by a government-approved laboratory for Safety certification, Fire testing, Restriction of Hazardous Substances (RoHS), Photobiological safety of lamps and lamp systems. (an Exemption Group) and other test certifications to ensure product quality.

光效 (lm/W)、功率 (W)、顯色指數 (CRI)，可根據客戶需求定制。

此型號標準之功率因素 (PF) > 0.9，總諧波指數 THD < 15%，可按客戶需要生產低總諧波指數 < 10%。

此型號認證由可實驗室發出之安全認證消防測試，環保物料 (RoHS)，光生物安全為 Exemption Group 及其它測試，保證客戶使用更安心滿意。



# Wide Angle LED T8 Tube

Series Type: S

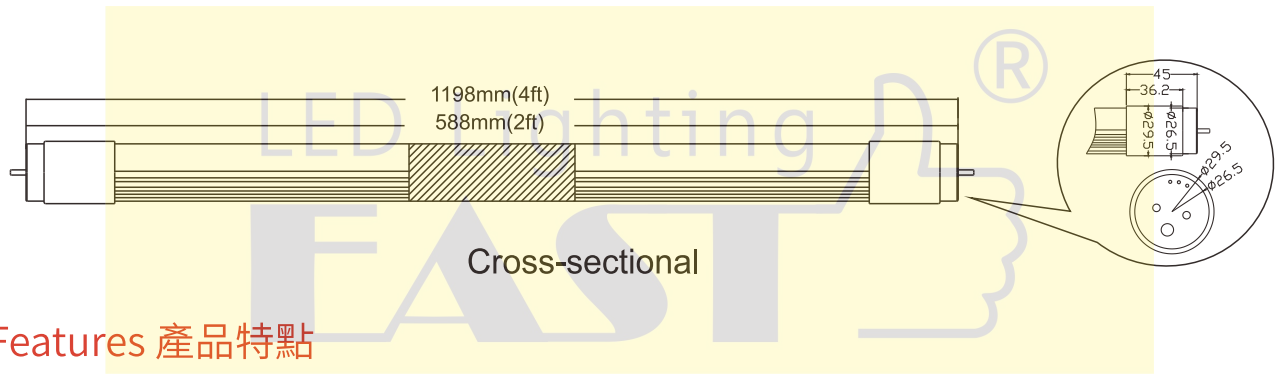

## Features 產品特點

- |  |  |
|--|--|
| <ul style="list-style-type: none"> <li>★ Uniform illumination</li> <li>★ Modification of existing T8 lamps</li> <li>★ SPM design - power circuit protection, which cuts off a single LED circuit in case of individual led failure</li> <li>★ The latest LED lighting standards IEC62560, EN62776 and EN62493 are certified</li> <li>★ Wide angle (300 degrees) to provide the best lighting effect</li> </ul> | <ul style="list-style-type: none"> <li>★ 均匀发光</li> <li>★ 对现有T8灯进行改造</li> <li>★ SPM设计-电源电路保护，当个别LED故障时切断单个LED电路</li> <li>★ 最新LED照明标准IEC62560、EN62776、EN62493认证</li> <li>★ 广角（300度）提供最佳照明效果</li> </ul> |
|--|--|

## Specification 產品規格

Model 型號	Voltage 電壓	Wattage 功率	Length 長度	Lamp Life 光度壽命	Colour Temp 色溫	Lumen Output 輸出流明	Color Rendering 顯色度	Lamp Base 燈腳	PCS/CTN 每箱數量
	(V)	(W)	(mm)	(Hrs)	(K)	(Lm/W)	(CRI)		(pcs)
EL-I1218-S118A4	100~240	18	1200	20,000	4000	110	>80	T8,G13	25
EL-I1218-S118A6	100~240	18	1200	20,000	6000	110	>80	T8,G13	25
EL-I0609-S118A4	100~240	9	600	20,000	4000	110	>80	T8,G13	25
EL-I0609-S118A6	100~240	9	600	20,000	6000	110	>80	T8,G13	25

Light efficiency (lm/W), Power (W), Color Rendering Index (CRI), Can be customized according to customer needs.  
 Our Standard Power factor (PF) > 0.9 and Total harmonic index THD < 15%, According to customer requirements can produce a lower THD < 10%.  
 This type of certification is issued by a government-approved laboratory for Safety certification, Fire testing, Restriction of Hazardous Substances (RoHS), Photobiological safety of lamps and lamp systems. (an Exemption Group) and other test certifications to ensure product quality.

光效 (lm/W)、功率 (W)、顯色指數 (CRI)，可根據客戶需求定制。  
 此型號標準之功率因素 (PF) > 0.9，總諧波指數 THD < 15%，可按客戶需要生產低總諧波指數 < 10%。  
 此型號認證由可實驗室發出之安全認證消防測試，環保物料 (RoHS)，光生物安全為 Exemption Group 及其它測試，保證客戶使用更安心滿意。

# DC LED T8 Tube With External Driver

Series Type: R-N



Model:LD-LT20

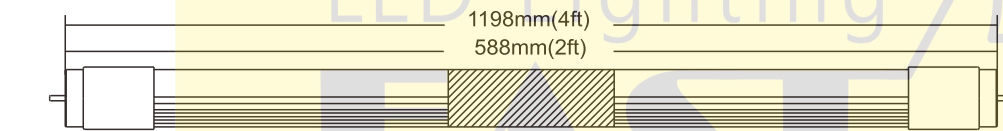

Cross-sectional

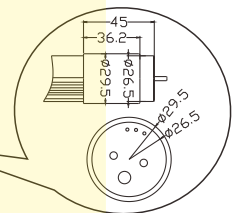
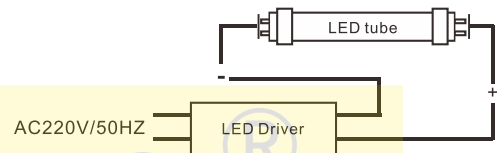

## Features 產品特點

- ★ Uniform light emission
- ★ Modification of existing T8 lamps
- ★ SPM design, namely tube source circuit protection, can immediately cut off a single LED circuit in case of fault

- ★ 發光均勻
- ★ 對現有T8燈進行改造
- ★ SPM設計即管源電路保護，在故障時可立即切斷單個LED電路

## Specification 產品規格

Model 型號	Voltage 電壓 (V)	Wattage 功率 (W)	Length 長度 (mm)	Lamp Life 光度壽命 (Hrs)	Colour Temp 色溫 (K)	Lumen Output 輸出流明 (Lm/W)	Color Rendering 顯色度 (CRI)	Lamp Base 燈腳	PCS/CTN 每箱數量 (pcs)
EL-R1218-N128A4	30-42	18	1200	20,000	4000	120	>80	T8,G13	25
EL-R1218-N128A6	30-42	18	1200	20,000	6000	120	>80	T8,G13	25
EL-R0609-N128A4	30-42	9	600	20,000	4000	120	>80	T8,G13	25
EL-R0609-N128A6	30-42	9	600	20,000	6000	120	>80	T8,G13	25

Light efficiency (lm/W), Power (W), Color Rendering Index (CRI), Can be customized according to customer needs.

Our Standard Power factor (PF) > 0.9 and Total harmonic index THD < 15%, According to customer requirements can produce a lower THD < 10%.

This type of certification is issued by a government-approved laboratory for Safety certification, Fire testing, Restriction of Hazardous Substances (RoHS), Photobiological safety of lamps and lamp systems. (an Exemption Group) and other test certifications to ensure product quality.

光效 (lm/W)、功率 (W)、顯色指數 (CRI)，可根據客戶需求定制。

此型號標準之功率因素 (PF) > 0.9，總諧波指數 THD < 15%，可按客戶需要生產低總諧波指數 < 10%。

此型號認證由可實驗室發出之安全認證消防測試，環保物料 (RoHS)，光生物安全為 Exemption Group 及其它測試，保證客戶使用更安心滿意。

# Dimmable LED T8 DC Tube & DALI LED Driver

Series Type: R-S

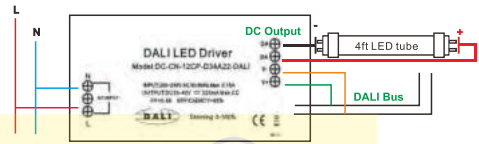
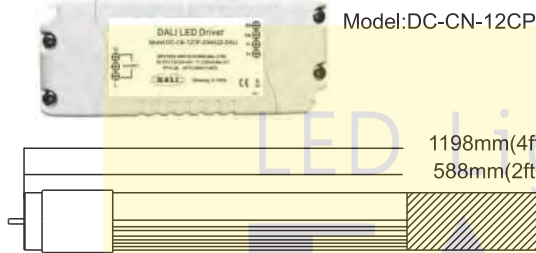

Cross-sectional

## Features 產品特點

- ★ Dimming interface: Dali
- ★ Constant current output, reference application, customizable 12W secondary LED power supply, double isolation
- ★ Short circuit, overcurrent and overvoltage protection, with efficiency up to 83%
- ★ Dali control input < 2mA, 5-100% envelope dimming range
- ★ Compatible with Philips, OSRAM, Tridonic, Siemens, virtual dragon, KNX and other dimming systems

- ★ 調光介面：DALI
- ★ 恒流輸出，參數可定制12W二級LED電源，雙隔離
- ★ 短路、過流、過電壓保護，效率高達83%
- ★ DALI控制輸入<2mA，5-100%封數調光範圍
- ★ 相容飛利浦、歐司朗、Tridonic、西門子、虛特龍、KNX等各種調光系統

## Specification 產品規格

Model 型號	Voltage 電壓	Wattage 功率	Length 長度	Lamp Life 光度壽命	Colour Temp 色溫	Lumen Output 輸出流明	Color Rendering 顯色度	Lamp Base 燈腳	PCS/CTN 每箱數量
	(V)	(W)	(mm)	(Hrs)	(K)	(Lm/W)	(CRI)		(pcs)
EL-R1218-S128A4	30-42	18	1200	20,000	4000	120	>80	T8,G13	25
EL-R1218-S128A6	30-42	18	1200	20,000	6000	120	>80	T8,G13	25
EL-R0609-S128A4	30-42	9	600	20,000	4000	120	>80	T8,G13	25
EL-R0609-S128A6	30-42	9	600	20,000	6000	120	>80	T8,G13	25

Light efficiency (lm/W), Power (W), Color Rendering Index (CRI), Can be customized according to customer needs.

Our Standard Power factor (PF) > 0.9 and Total harmonic index THD < 15%, According to customer requirements can produce a lower THD < 10%.

This type of certification is issued by a government-approved laboratory for Safety certification, Fire testing, Restriction of Hazardous Substances (RoHS), Photobiological safety of lamps and lamp systems. (an Exemption Group) and other test certifications to ensure product quality.

光效 (lm/W)、功率 (W)、顯色指數 (CRI)，可根據客戶需求定制。

此型號標準之功率因素 (PF) > 0.9，總諧波指數 THD < 15%，可按客戶需要生產低總諧波指數 < 10%。

此型號認證由可實驗室發出之安全認證消防測試，環保物料 (RoHS)，光生物安全為 Exemption Group 及其它測試，保證客戶使用更安心滿意。

# Dimmable LED T8 DC Tube & 0-10V LED Driver

Series Type: R-N

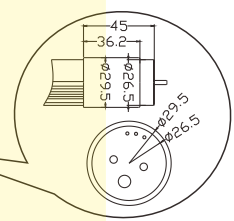
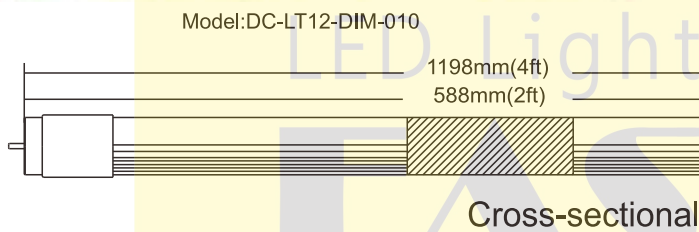
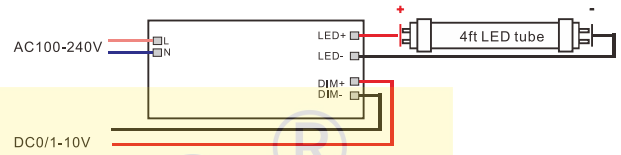

## Features 產品特點

- ★ Dimming interface; 0-10V dimming
- ★ For leading and trailing edge 0-10V dimmers
- ★ Comply with safety extra low voltage standards

- ★ 調光介面;0-10V調光
- ★ 適用於前緣和後緣0-10V調光器
- ★ 符合安全特低電壓標準相容

## Specification 產品規格

Model 型號	Voltage 電壓 (V)	Wattage 功率 (W)	Length 長度 (mm)	Lamp Life 光度壽命 (Hrs)	Colour Temp 色溫 (K)	Lumen Output 輸出流明 (Lm/W)	Color Rendering 顯色度 (CRI)	Lamp Base 燈腳	PCS/CTN 每箱數量 (pcs)
EL-R1218-N128A4	30-42	18	1200	20,000	4000	120	>80	T8,G13	25
EL-R1218-N128A6	30-42	18	1200	20,000	6000	120	>80	T8,G13	25
EL-R0609-N128A4	30-42	9	600	20,000	4000	120	>80	T8,G13	25
EL-R0609-N128A6	30-42	9	600	20,000	6000	120	>80	T8,G13	25

Light efficiency (lm/W), Power (W), Color Rendering Index (CRI), Can be customized according to customer needs.  
 Our Standard Power factor (PF) > 0.9 and Total harmonic index THD < 15%, According to customer requirements can produce a lower THD < 10%.  
 This type of certification is issued by a government-approved laboratory for Safety certification, Fire testing, Restriction of Hazardous Substances (RoHS), Photobiological safety of lamps and lamp systems. (an Exemption Group) and other test certifications to ensure product quality.

光效 (lm/W)、功率 (W)、顯色指數 (CRI), 可根據客戶需求定制。  
 此型號標準之功率因素 (PF) > 0.9, 總諧波指數 THD < 15%, 可按客戶需要生產低總諧波指數 < 10%。  
 此型號認證由可實驗室發出之安全認證消防測試, 環保物料 (RoHS), 光生物安全為 Exemption Group 及其它測試, 保證客戶使用更安心滿意。

# T5 DC Tube And Driver

Series Type: R5-N

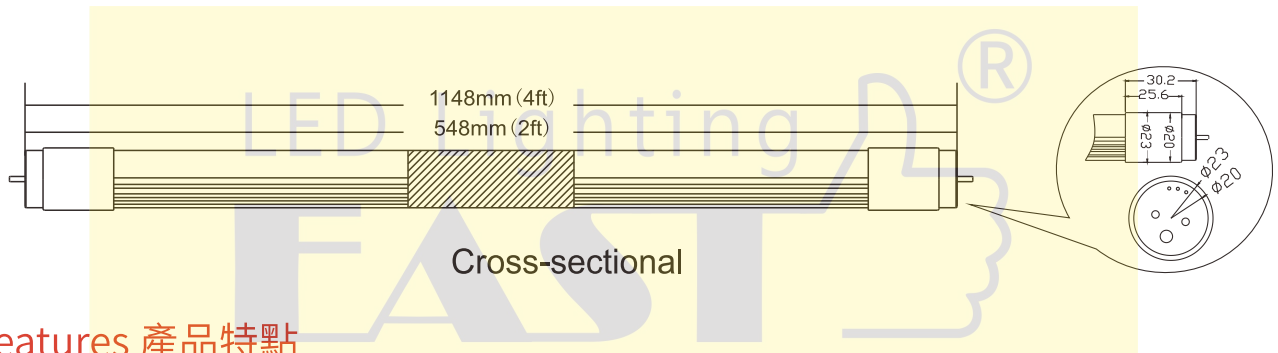

## Features 產品特點

- |  |   |
|--|---|
| <ul style="list-style-type: none"> <li>★ Uniform light emission</li> <li>★ High luminous output 155lm/w &amp; lower power consumption</li> <li>★ SPM design, namely tube source circuit protection, can immediately cut off a single LED circuit in case of fault</li> <li>★ T6 tube body to achieve the best lighting effect</li> <li>★ Low THD &lt; 10%</li> </ul> | <ul style="list-style-type: none"> <li>★ 均匀发光</li> <li>★ 高发光输出155 lm/w，低功耗</li> <li>★ SPM設計即管源電路保護，在故障時可立即切斷單個LED電路</li> <li>★ T6管體達到最佳照明效果</li> <li>★ 低THD&lt;10%</li> </ul> |
|--|---|

## Specification 產品規格

Model 型號	Voltage 電壓	Wattage 功率	Length 長度	Lamp Life 光度壽命	Colour Temp 色溫	Lumen Output 輸出流明	Color Rendering 顯色度	Lamp Base 燈腳	PCS/CTN 每箱數量
	(V)	(W)	(mm)	(Hrs)	(K)	(Lm/W)	(CRI)		(pcs)
EL-R51216-N128A4	30-36	16	1200	20,000	4000	155	>80	T5,G5	50
EL-R51216-N128A6	30-36	16	1200	20,000	6000	155	>80	T5,G5	50
EL-R50608-N128A4	30-36	8	600	20,000	4000	155	>80	T5,G5	50
EL-R50608-N128A6	30-36	8	600	20,000	6000	155	>80	T5,G5	50

Light efficiency (lm/W), Power (W), Color Rendering Index (CRI), Can be customized according to customer needs.  
 Our Standard Power factor (PF) > 0.9 and Total harmonic index THD < 15%, According to customer requirements can produce a lower THD < 10%.  
 This type of certification is issued by a government-approved laboratory for Safety certification, Fire testing, Restriction of Hazardous Substances (RoHS), Photobiological safety of lamps and lamp systems. (an Exemption Group) and other test certifications to ensure product quality.

光效 (lm/W)、功率 (W)、顯色指數 (CRI)，可根據客戶需求定制。  
 此型號標準之功率因素 (PF) > 0.9，總諧波指數 THD < 15%，可按客戶需要生產低總諧波指數 < 10%。  
 此型號認證由可實驗室發出之安全認證消防測試，環保物料 (RoHS)，光生物安全為 Exemption Group 及其它測試，保證客戶使用更安心滿意。

# Manual Preset Power Consumption AC T8 Tube

Series Type: DP

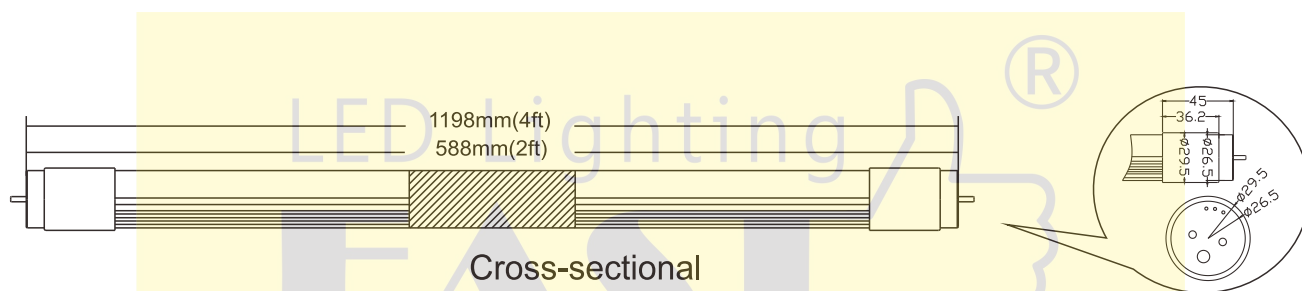

## Features 產品特點

- ★ Uniform light emission
- ★ Selector with 4-bit dip switch
- ★ Dimming range from 100% to 50% (100%, 85%, 75%, 50%)
- ★ SPM design, namely power circuit protection, can immediately cut off a single LED circuit in case of fault

- ★ 發光均勻
- ★ 帶4比特dip開關選擇器
- ★ 調光範圍從100%到50% (100%, 85%, 75%, 50%)
- ★ SPM設計即電源電路保護，在故障時可立即切斷單個LED電路

## Specification 產品規格

Model 型號	Voltage 電壓 (V)	Wattage 功率 (W)	Length 長度 (mm)	Lamp Life 光度壽命 (Hrs)	Colour Temp 色溫 (K)	Lumen Output 輸出流明 (Lm/W)	Color Rendering 顯色度 (CRI)	Lamp Base 燈腳	PCS/CTN 每箱數量 (pcs)
EL-I1218-DP128A4	100-240	18	1200	20,000	4000	120	>80	T8,G13	25
EL-I1218-DP128A6	100-240	18	1200	20,000	6000	120	>80	T8,G13	25
EL-I0609-DP128A4	100-240	9	600	20,000	4000	120	>80	T8,G13	25
EL-I0609-DP128A6	100-240	9	600	20,000	6000	120	>80	T8,G13	25

Light efficiency (lm/W), Power (W), Color Rendering Index (CRI), Can be customized according to customer needs.

Our Standard Power factor (PF) > 0.9 and Total harmonic index THD < 15%, According to customer requirements can produce a lower THD < 10%.

This type of certification is issued by a government-approved laboratory for Safety certification, Fire testing, Restriction of Hazardous Substances (RoHS), Photobiological safety of lamps and lamp systems. (an Exemption Group) and other test certifications to ensure product quality.

光效 (lm/W)、功率 (W)、顯色指數 (CRI)，可根據客戶需求定制。

此型號標準之功率因素 (PF) > 0.9，總諧波指數 THD < 15%，可按客戶需要生產低總諧波指數 < 10%。

此型號認證由可實驗室發出之安全認證消防測試，環保物料 (RoHS)，光生物安全為 Exemption Group 及其它測試，保證客戶使用更安心滿意。

# Time Control ON/OFF LED T8 Tube

Series Type: SL

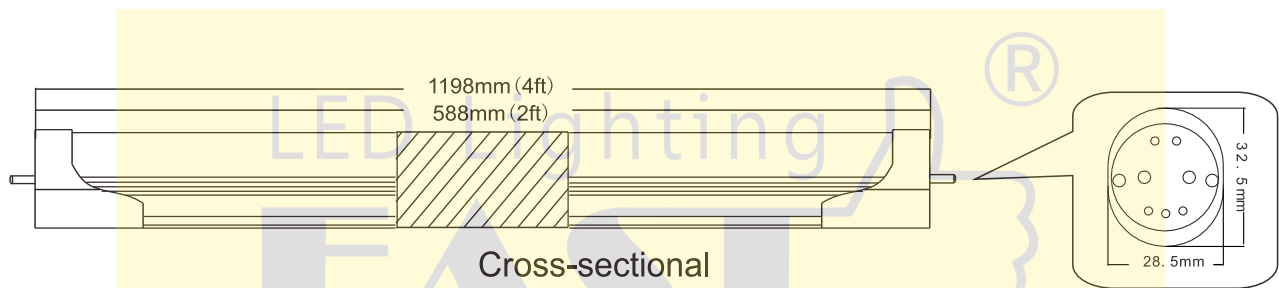

## Features 產品特點

- ★ Uniform luminescence
- ★ The existing T8 light tube is reformed
- ★ SPM design - power circuit protection, when the individual led failure to cut off a single LED circuit
- ★ Dial code from minimum 0.5 hours to 24 hours delay combination
- ★ The daily running time can be customized according to the demand
- ★ 撥碼由最小0.5小時至組合24小時延時組合
- ★ 設置每天運行
- ★ 發光均勻
- ★ 對現有的T8燈管進行改造
- ★ SPM設計即電源電路保護，在故障時可立即切斷單個LED電路

## Specification 產品規格

Model 型號	Voltage 電壓	Wattage 功率	Length 長度	Lamp Life 光度壽命	Colour Temp 色溫	Lumen Output 輸出流明	Color Rendering 顯色度	Lamp Base 燈腳	PCS/CTN 每箱數量
	(V)	(W)	(mm)	(Hrs)	(K)	(Lm/W)	(CRI)		(pcs)
EL-I1218-SL128A4	100-240	18	1200	20,000	4000	100	>80	T8,G13	25
EL-I1218-SL128A6	100-240	18	1200	20,000	6000	100	>80	T8,G13	25
EL-I0609-SL128A4	100-240	9	600	20,000	4000	100	>80	T8,G13	25
EL-I0609-SL128A6	100-240	9	600	20,000	6000	100	>80	T8,G13	25

Light efficiency (lm/W), Power (W), Color Rendering Index (CRI), Can be customized according to customer needs.

Our Standard Power factor (PF) > 0.9 and Total harmonic index THD < 15%, According to customer requirements can produce a lower THD < 10%.

This type of certification is issued by a government-approved laboratory for Safety certification, Fire testing, Restriction of Hazardous Substances (RoHS), Photobiological safety of lamps and lamp systems. (an Exemption Group) and other test certifications to ensure product quality.

光效 (lm/W)、功率 (W)、顯色指數 (CRI)，可根據客戶需求定制。

此型號標準之功率因素 (PF) > 0.9，總諧波指數 THD < 15%，可按客戶需要生產低總諧波指數 < 10%。

此型號認證由可實驗室發出之安全認證消防測試，環保物料 (RoHS)，光生物安全為 Exemption Group 及其它測試，保證客戶使用更安心滿意。

# Phase Control Dimming LED T8 Tube

Series Type: LE

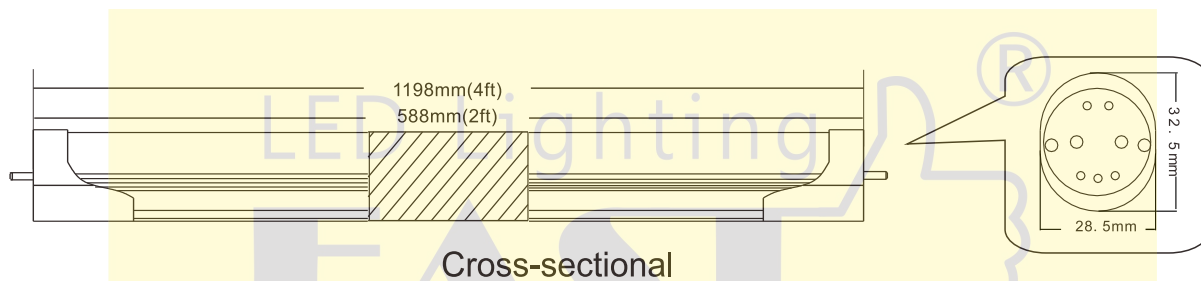

## Features 產品特點

- ★ Dimming range 30-100% efficiency > 85%
- ★ Dimming interface: traic / ELV, key dimmer
- ★ Suitable for front cut or back cut dimmers
- ★ PWM digital dimming, high frequency PWM dimming without changing LED color rendering index
- ★ Short circuit / overheating / overload / overvoltage protection
- ★ Daohe indoor environment

- ★ 調光範圍30-100% 效率>85%
- ★ 調光介面：Traic/ELV，按鍵調光器
- ★ 適用於前切式或後切式調光器
- ★ PWM數位調光，不改變LED顯色指數高頻PWM調光
- ★ 短路/過熱/超載/過壓保護
- ★ 道合室內環境

## Specification 產品規格

Model 型號	Voltage 電壓	Wattage 功率	Length 長度	Lamp Life 光度壽命	Colour Temp 色溫	Lumen Output 輸出流明	Color Rendering 顯色度	Lamp Base 燈腳	PCS/CTN 每箱數量
	(V)	(W)	(mm)	(Hrs)	(K)	(Lm/W)	(CRI)		(pcs)
EL-I1218-LE128A4	100-240	18	1200	20,000	4000	120	>80	T8,G13	25
EL-I1218-LE128A6	100-240	18	1200	20,000	6000	120	>80	T8,G13	25
EL-I0609-LE128A4	100-240	9	600	20,000	4000	120	>80	T8,G13	25
EL-I0609-LE128A6	100-240	9	600	20,000	6000	120	>80	T8,G13	25

Light efficiency (lm/W), Power (W), Color Rendering Index (CRI), Can be customized according to customer needs.

Our Standard Power factor (PF) > 0.9 and Total harmonic index THD < 15%, According to customer requirements can produce a lower THD < 10%.

This type of certification is issued by a government-approved laboratory for Safety certification, Fire testing, Restriction of Hazardous Substances (RoHS), Photobiological safety of lamps and lamp systems. (an Exemption Group) and other test certifications to ensure product quality.

光效 (lm/W)、功率 (W)、顯色指數 (CRI)，可根據客戶需求定制。

此型號標準之功率因素 (PF) > 0.9，總諧波指數 THD < 15%，可按客戶需要生產低總諧波指數 < 10%。

此型號認證由可實驗室發出之安全認證消防測試，環保物料 (RoHS)，光生物安全為 Exemption Group 及其它測試，保證客戶使用更安心滿意。



# T5 Integrated LED Tube

Series Type: T5-IB

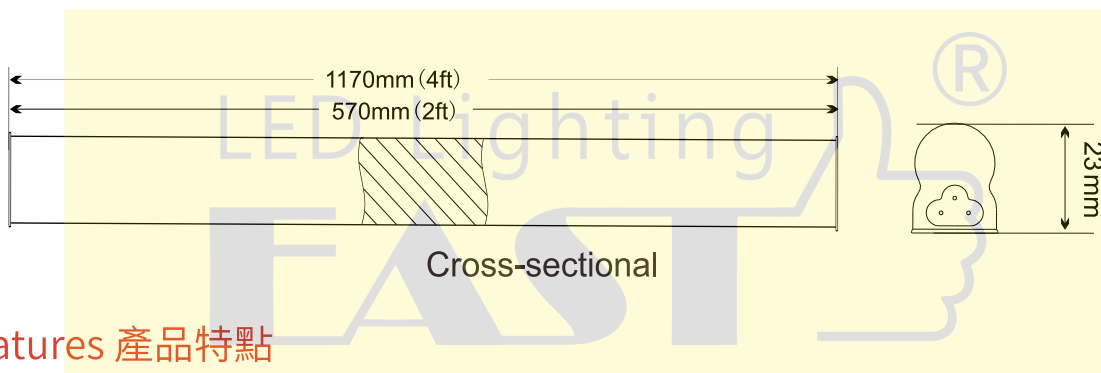

## Features 產品特點

- ★ T5 integrated pipe with internal driver bracket
- ★ Pipes connected together by plugs or cables
- ★ Seamless lighting output without dark spots
- ★ Suitable for shallow grooves

- ★ 帶內部驅動器支架的T5集成管
- ★ 通過插頭或電纜連接在一起的管子
- ★ 無縫照明輸出，無暗點
- ★ 適用於淺槽

## Specification 產品規格

Model 型號	Voltage 電壓 (V)	Wattage 功率 (W)	Length 長度 (mm)	Lamp Life 光度壽命 (Hrs)	Colour Temp 色溫 (K)	Lumen Output 輸出流明 (Lm/W)	Color Rendering 顯色度 (CRI)	PCS/CTN 每箱數量 (pcs)
EL-I51216-IB128A4	100-240	16	1200	20,000	4000	120	>80	25
EL-I51216-IB128A6	100-240	16	1200	20,000	6000	120	>80	25
EL-I50608-IB128A4	100-240	8	600	20,000	4000	120	>80	25
EL-I50608-IB128A6	100-240	8	600	20,000	6000	120	>80	25

Light efficiency (lm/W), Power (W), Color Rendering Index (CRI), Can be customized according to customer needs.

Our Standard Power factor (PF) > 0.9 and Total harmonic index THD < 15%, According to customer requirements can produce a lower THD < 10%.

This type of certification is issued by a government-approved laboratory for Safety certification, Fire testing, Restriction of Hazardous Substances (RoHS), Photobiological safety of lamps and lamp systems. (an Exemption Group) and other test certifications to ensure product quality.

光效 (lm/W)、功率 (W)、顯色指數 (CRI)，可根據客戶需求定制。

此型號標準之功率因素 (PF) > 0.9，總諧波指數 THD < 15%，可按客戶需要生產低總諧波指數 < 10%。

此型號認證由可實驗室發出之安全認證消防測試，環保物料 (RoHS)，光生物安全為 Exemption Group 及其它測試，保證客戶使用更安心滿意。

# T5 Integrated LED Tube + ON/OFF

Series Type: T5-BS

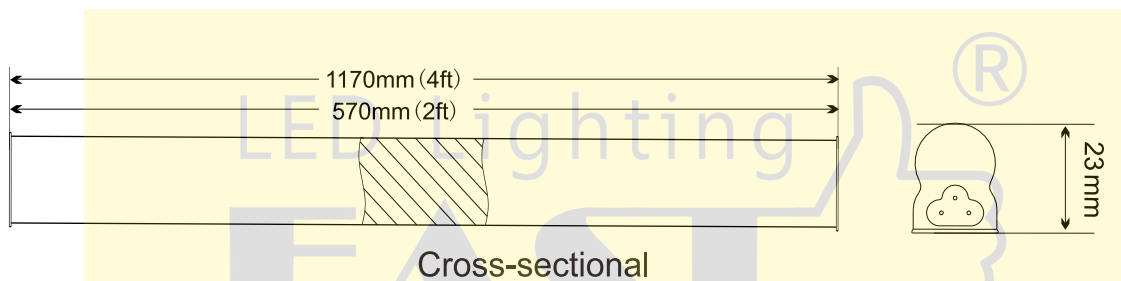

## Features 產品特點

- ★ T5 integrated pipe with internal driver bracket
- ★ Pipes connected together by plugs or cables
- ★ Seamless lighting output without dark spots
- ★ Suitable for shallow grooves
- ★ With switch

- ★ 帶內部驅動器支架的T5集成管
- ★ 通過插頭或電纜連接在一起的管子
- ★ 無縫照明輸出，無暗點
- ★ 適用於淺槽
- ★ 帶開關

## Specification 產品規格

Model 型號	Voltage 電壓	Wattage 功率	Length 長度	Lamp Life 光度壽命	Colour Temp 色溫	Lumen Output 輸出流明	Color Rendering 顯色度	PCS/CTN 每箱數量
	(V)	(W)	(mm)	(Hrs)	(K)	(Lm/W)	(CRI)	(pcs)
EL-I51216-BS128A4	100-240	16	1200	20,000	4000	120	>80	25
EL-I51216-BS128A6	100-240	16	1200	20,000	6000	120	>80	25
EL-I50608-BS128A4	100-240	8	600	20,000	4000	120	>80	25
EL-I50608-BS128A6	100-240	8	600	20,000	6000	120	>80	25

Light efficiency (lm/W), Power (W), Color Rendering Index (CRI), Can be customized according to customer needs.

Our Standard Power factor (PF) > 0.9 and Total harmonic index THD < 15%, According to customer requirements can produce a lower THD < 10%.

This type of certification is issued by a government-approved laboratory for Safety certification, Fire testing, Restriction of Hazardous Substances (RoHS), Photobiological safety of lamps and lamp systems. (an Exemption Group) and other test certifications to ensure product quality.

光效 (lm/W)、功率 (W)、顯色指數 (CRI)，可根據客戶需求定制。

此型號標準之功率因素 (PF) > 0.9，總諧波指數 THD < 15%，可按客戶需要生產低總諧波指數 < 10%。

此型號認證由可實驗室發出之安全認證消防測試，環保物料 (RoHS)，光生物安全為 Exemption Group 及其它測試，保證客戶使用更安心滿意。

# LED PLC Tube

Series Type: C

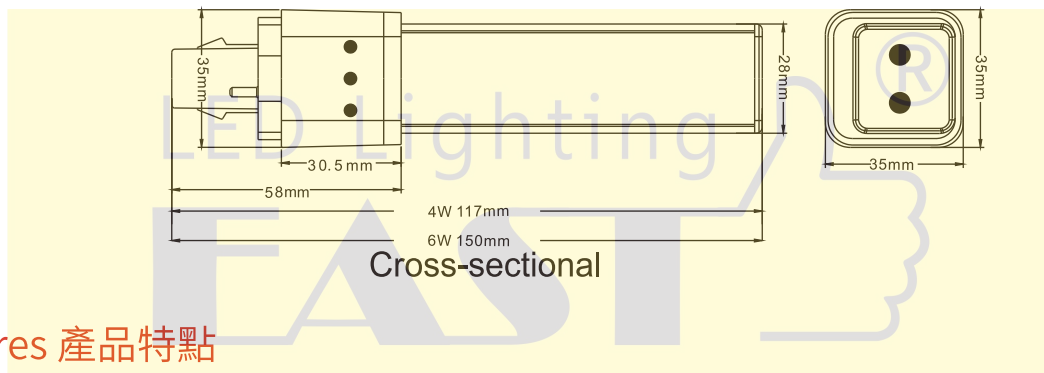
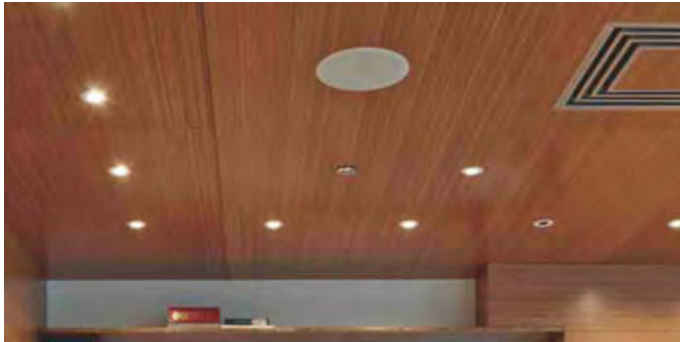

## Features 產品特點

- ★ Beautiful and delicate appearance, suitable for home and commercial use
- ★ Shuxin light quality, color rendering index 80, eliminate stroboscopic, no mercury or other harmful substances
- ★ Long and durable, with an average life of 30000 hours, environmental protection and energy saving
- ★ High quality aluminum heat dissipation design, extend the service life of products
- ★ Easy to install, easy to replace, plug and play, no need to change the line, compatible with the original ballast and lamps

- ★ 外形美觀纖巧，適用於家居及商業使用
- ★ 舒心光質，顯色指數80，消除頻閃，不含汞或其他有害物質
- ★ 長壽耐用，平均壽命高達30,000小時，環保慳電
- ★ 優質鋁散熱設計，延長產品使用壽命
- ★ 安裝簡易，輕鬆替換，即插即用，無需改線，相容原有鎮流器和燈具

## Specification 產品規格

Model 型號	Voltage 電壓	Wattage 功率	Length 長度	Lamp Life 光度壽命	Colour Temp 色溫	Lumen Output 輸出流明	Color Rendering 顯色度	Lamp Base 燈腳	PCS/CTN 每箱數量
	(V)	(W)	(mm)	(Hrs)	(K)	(Lm/W)	(CRI)		(pcs)
EPL-C04-H108A6	100-240	4	117	30,000	6000	100	>80	G24	25
EPL-C06-H108A4	100-240	6	150	30,000	4000	100	>80	G24	25

Light efficiency (lm/W), Power (W), Color Rendering Index (CRI), Can be customized according to customer needs.

Our Standard Power factor (PF) > 0.9 and Total harmonic index THD < 15%, According to customer requirements can produce a lower THD < 10%.

This type of certification is issued by a government-approved laboratory for Safety certification, Fire testing, Restriction of Hazardous Substances (RoHS), Photobiological safety of lamps and lamp systems. (an Exemption Group) and other test certifications to ensure product quality.

光效 (lm/W)、功率 (W)、顯色指數 (CRI)，可根據客戶需求定制。

此型號標準之功率因素 (PF) > 0.9，總諧波指數 THD < 15%，可按客戶需要生產低總諧波指數 < 10%。

此型號認證由可實驗室發出之安全認證消防測試，環保物料 (RoHS)，光生物安全為 Exemption Group 及其它測試，保證客戶使用更安心滿意。

# LED PLS Tube

Series Type: S

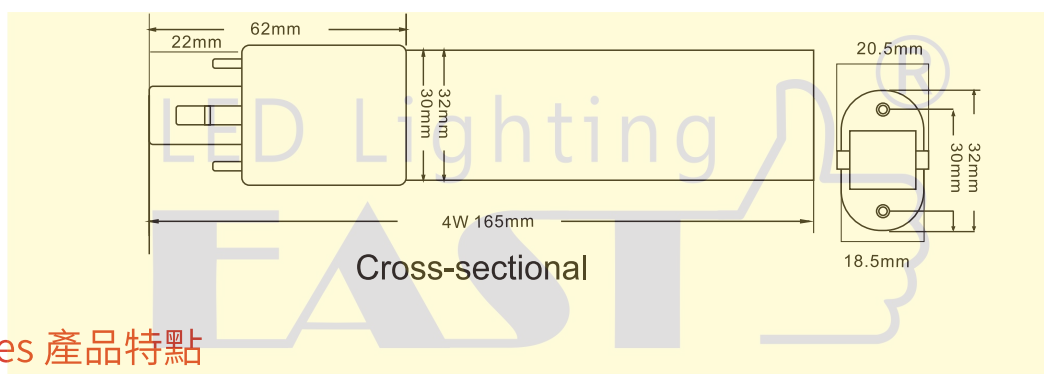

## Features 產品特點

- ★ Energy saving: 80% more energy-saving than traditional incandescent bulbs
  - ★ Ecological green: no radiation, mercury, lead and coke harmful elements, and all products can be recycled
  - ★ Long service life: use 50000 small poems of poison life, which is 10 times that of traditional light source
  - ★ High luminous efficiency: the product can reach 120lm / W
  - ★ It is safe and easy to use and install
  - ★ This product is applicable to indoor places requiring high brightness and energy saving, such as cars, offices, banks, hospitals, shopping malls, MRT, schools and so on
- ★ 節能：比傳統白熾燈泡節能80%
  - ★ 生態綠色：無輻射、無汞、無鉛、焦有害元素，所有產品均可回收利用
  - ★ 壽命長：使用壽命50000小時，是傳統光源的10倍
  - ★ 高光效：產品可達120lm/W
  - ★ 它很安全，易於使用和安裝
  - ★ 本產品適用於車間、辦公室、銀行、醫院、商場、捷運、學校等要求高亮度、節能的室內場所

## Specification 產品規格

Model 型號	Voltage 電壓 (V)	Wattage 功率 (W)	Length 長度 (mm)	Lamp Life 光度壽命 (Hrs)	Colour Temp 色溫 (K)	Lumen Output 輸出流明 (Lm/W)	Color Rendering 顯色度 (CRI)	Lamp Base 燈腳	PCS/CTN 每箱數量 (pcs)
EPL-S04-H128A4	85-265	4	165	20,000	4000	100	>80	G23	25
EPL-S04-H128A6	85-265	4	165	20,000	6000	100	>80	G23	25

Light efficiency (lm/W), Power (W), Color Rendering Index (CRI), Can be customized according to customer needs.  
 Our Standard Power factor (PF) > 0.9 and Total harmonic index THD < 15%, According to customer requirements can produce a lower THD < 10%.  
 This type of certification is issued by a government-approved laboratory for Safety certification, Fire testing, Restriction of Hazardous Substances (RoHS), Photobiological safety of lamps and lamp systems. (an Exemption Group) and other test certifications to ensure product quality.

光效 (lm/W)、功率 (W)、顯色指數 (CRI)，可根據客戶需求定制。  
 此型號標準之功率因素 (PF) > 0.9，總諧波指數 THD < 15%，可按客戶需要生產低總諧波指數 < 10%。  
 此型號認證由可實驗室發出之安全認證消防測試，環保物料 (RoHS)，光生物安全為 Exemption Group 及其它測試，保證客戶使用更安心滿意。

# LED PLC Tube

Series Type: L

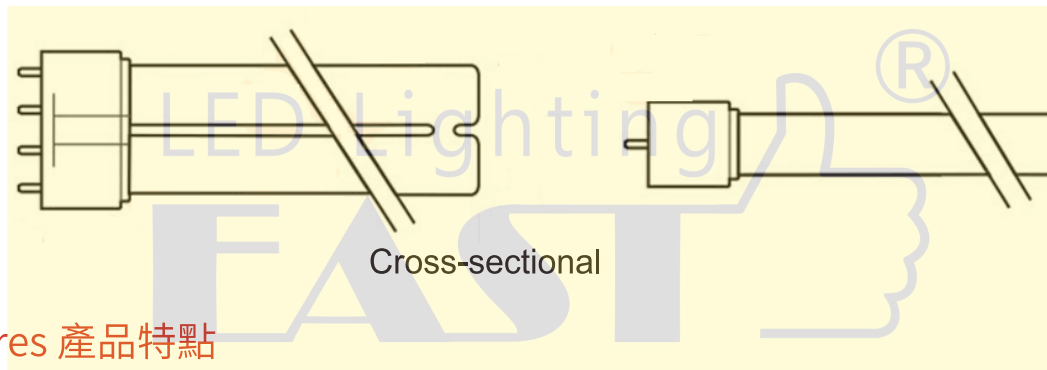

## Features 產品特點

- ★ Energy saving: 80% more energy-saving than traditional incandescent bulbs
  - ★ Ecological green: no radiation, mercury, lead and coke harmful elements, and all products can be recycled
  - ★ Long service life: use 50000 small poems of poison life, which is 10 times that of traditional light source
  - ★ High luminous efficiency: the product can reach 120lm / W
  - ★ It is safe and easy to use and install
  - ★ This product is applicable to indoor places requiring high brightness and energy saving, such as cars, offices, banks, hospitals, shopping malls, MRT, schools and so on
- ★ 節能：比傳統白熾燈泡節能80%
  - ★ 生態綠色：無輻射、無汞、無鉛、焦有害元素，所有產品均可回收利用
  - ★ 壽命長：使用壽命50000小時，是傳統光源的10倍
  - ★ 高光效：產品可達120lm/W
  - ★ 它很安全，易於使用和安裝
  - ★ 本產品適用於車間、辦公室、銀行、醫院、商場、捷運、學校等要求高亮度、節能的室內場所

## Specification 產品規格

Model 型號	Voltage 電壓	Wattage 功率	Length 長度	Lamp Life 光度壽命	Colour Temp 色溫	Lumen Output 輸出流明	Color Rendering 顯色度	Lamp Base 燈腳	PCS/CTN 每箱數量
	(V)	(W)	(mm)	(Hrs)	(K)	(Lm/W)	(CRI)		(pcs)
EPL-L0310-H128A4	85-265	10	320	20,000	4000	120	>80	2G11	25
EPL-L0310-H128A6	85-265	10	320	20,000	6000	120	>80	2G11	25

Light efficiency (lm/W), Power (W), Color Rendering Index (CRI), Can be customized according to customer needs.

Our Standard Power factor (PF) > 0.9 and Total harmonic index THD < 15%, According to customer requirements can produce a lower THD < 10%.

This type of certification is issued by a government-approved laboratory for Safety certification, Fire testing, Restriction of Hazardous Substances (RoHS), Photobiological safety of lamps and lamp systems. (an Exemption Group) and other test certifications to ensure product quality.

光效 (lm/W)、功率 (W)、顯色指數 (CRI)，可根據客戶需求定制。

此型號標準之功率因素 (PF) > 0.9，總諧波指數 THD < 15%，可按客戶需要生產低總諧波指數 < 10%。

此型號認證由可實驗室發出之安全認證消防測試，環保物料 (RoHS)，光生物安全為 Exemption Group 及其它測試，保證客戶使用更安心滿意。



東 櫛 LED 照 明 公 司  
EASTLIKE LED Co., Ltd

---

**Office Address:** Room B3, 18/F Bonsun Industrial Building,  
364-366 Sha Tsui Road, Tsuen Wan, HongKong

**Phone:** 852-3974 5593

**Fax:** 852-3544 0462

**Whatsapp:** +852-6756 770

**Email:** [info@eastlike.com](mailto:info@eastlike.com)