

LED LIGHTING SERIES

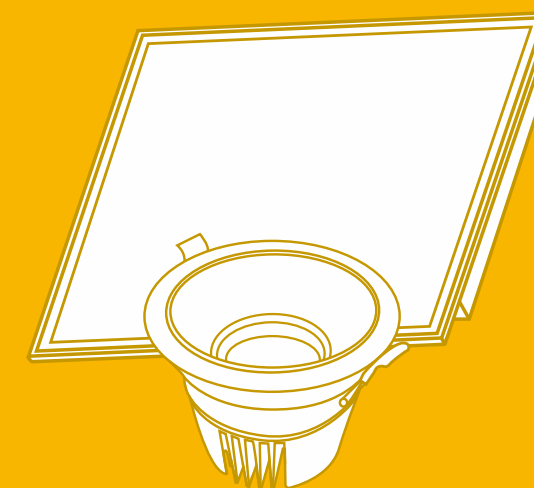

CATALOG

Panels and Ceiling Lights

iLighting Global Enterprise Co., Ltd.
www.ilighting.com.hk



iLighting Global Enterprise Co., Ltd.

Office Address: Room B3, 18/F Bonsun Industrial Building,
364-366 Sha Tsui Road, Tsuen Wan, HongKong

Phone: 852-3107 7500

Fax: 852-3544 0462

Email: info@ilighting.com.hk

Website: www.ilighting.com.hk



Panel And Downlight

LED Lighting Series



CONTENTS

CONTENTS

Company Profile 公司簡介

1-2

Lighting Basic Concept 照明基本概念

3-6

Panel Light 面板燈

7-19

Circular Light 圓盤燈

20-24

Downlight 天花燈

25-37

Track Light 軌道燈

38-48

Panels
And
Downlight



A

panel light

面板燈



P.08
PL-PN-N



P.09
PL-PN-T



P.10
PL-PN-M



P.11
PL-PN-F



P.12
PL-PN-C



P.13
PL-PN-C



P.14
PL-PN-Z



P.15
PL-PN-JS



P.16
PL-PN-XD



P.17
PL-PN-DX



P.18
PL-PN-A



P.19
PL-PN-P-D

B

circular lamp

圓盤燈



P.21
ILR-A



P.22
ILR-T-H



P.23
ILR-A-S



P.24
ILR-A

C

downlight

天花燈



P.26
DL-T



P.27
DL-H



P.28
DL-N



P.29
DL-L



P.30
DL-I



P.31
DL-R



P.32
DL-UC



P.33
DL-S



P.34
DL-OA



P.35
DL-0620



P.36
DL-0412



P.37
DL-0408

D

track light

軌道燈



P.39
TL-Q



P.40
TL-P



P.41
TL-OR



P.42
TL-F1



P.43
TL-K



P.44
TL-F1A



P.45
TL-F2



P.46
TL-O



P.47
TL-M



P.48
TL-F1R



Company Profile

公司簡介

● ABOUT US 關於我們

iLIGHTING Global Enterprise Co. Ltd. emerges as a professional and high-end lighting designer, manufacturer and supplier established in Hong Kong and Mainland China under the Brand name ' iLighting ' since 2007. The company is also a strategic OEM/ODM partner of many organization-wide lighting brands. Our company devotes herself in the development, manufacturing and marketing of green, low-carbon and energy-saving lighting products. With continuous investment on R&D , we are proud to provide a wide range of LED products and work with worldwide partners in developing and managing Energy Management System (EMS) through the application of 5G and WiFi technology.

iLIGHTING智能環球企業有限公司成立於2007年是一家集高端照明設計、製造和供應為一體的專業照明公司，自2007年起在香港和中國大陸以“iLighting”的名字成立。公司也是許多照明品牌的戰略性OEM/ODM合作夥伴。公司致力於綠色、低碳、節能照明產品的開發、製造和銷售。憑藉對研發的持續投資，我們自豪地提供範圍廣泛的LED產品，並通過應用5G和WiFi科技與全球合作夥伴合作開發和管理能源管理系統(EMS)。

● Product Capacity 生產能力

- LED lighting with integrated design and built-in advanced electronic driver for building lighting retrofit.
- LED indoor and outdoor lighting with internal and external drivers.
- LED lighting emergency fitting and charging packs.
- Extra long life LED lamps for high power high bay and flood lights.
- Total system solution for dimming lighting control deploying WiFi, DALI, Lonwork, Bluetooth 4.0, Zigbee technologies.
- OEM / ODM energy saving lighting as required by clients for new and retrofit installation.
- Total Energy Management Solution for Intelligent Building Management.
- LED照明與集成設計和內置先進的電子驅動器，用於建築照明改造。
- 室內和室外LED照明，有內部和外部驅動器。
- LED照明應急配件和充電器。
- 超長壽命LED燈，適用於大功率高位燈和泛光燈。
- 全系統調光照明控制解決方案，採用WiFi、DALI、Lonwork, Bluetooth 4.0, Zigbee 通訊技術。
- OEM/ODM節能照明，可根據客戶的要求進行更新改造。
- 智能建築管理總能源管理解決方案。

● Our Mission 我們的使命

We look to serve our client with the best quality of products and viable solutions of energy management system through intelligent system integration. Product adaptability is our strength ; continuous improvement is our norm of work and meeting customer satisfaction is our goal.

我們希望通過智能系統集成，為客戶提供最優質的產品和可行的能源管理系統解決方案。產品適應性是我們的優勢，持續改進是我們的工作準則，讓客戶滿意是我們的目標。

● Our Advantages 我們的優勢

- Excellent after-sale services.
- OEM and ODM for global lighting companies.
- Flexible design and tailor-made products to suit retrofit projects.
- 優良的售後服務。
- 為全球照明公司提供OEM和ODM。
- 靈活的設計和訂制的產品，以適應更新改造項目。

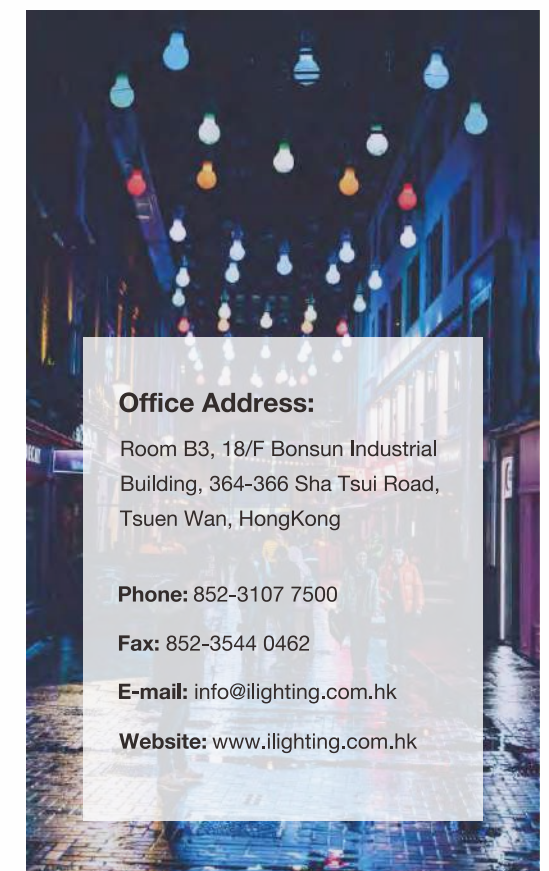

Office Address:

Room B3, 18/F Bonsun Industrial Building, 364-366 Sha Tsui Road, Tsuen Wan, HongKong

Phone: 852-3107 7500

Fax: 852-3544 0462

E-mail: info@ilighting.com.hk

Website: www.ilighting.com.hk

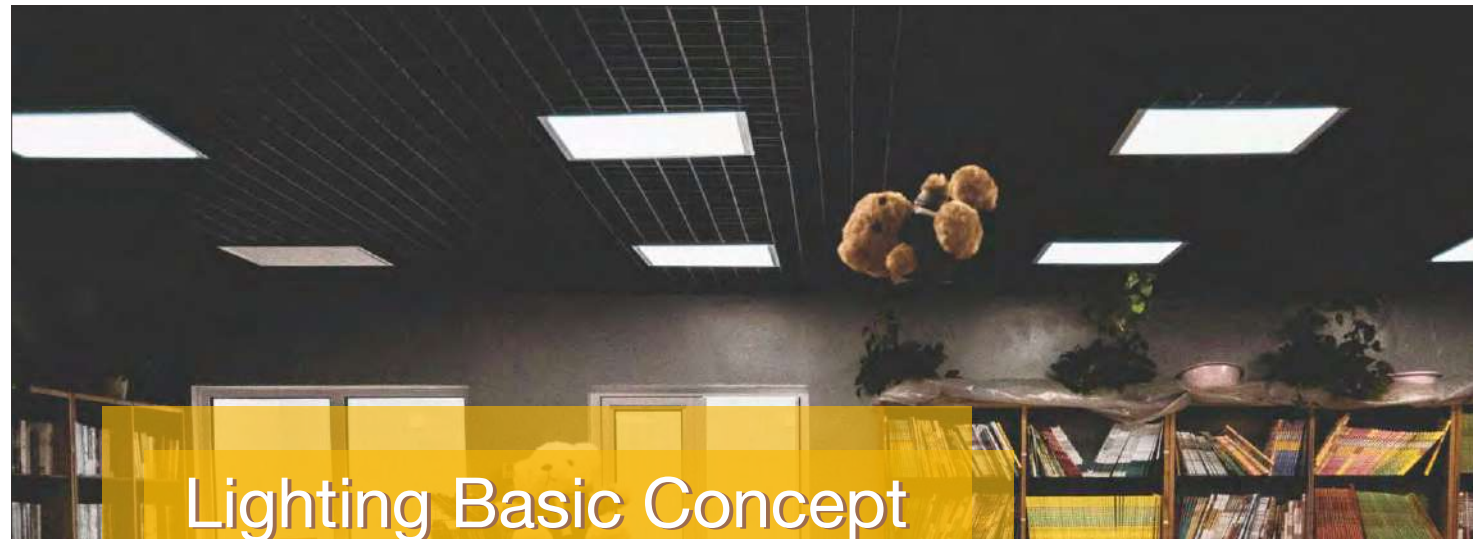

Lighting Basic Concept

照明基本概念



Lumen 流明

Lumen 實際上是代表著光的強度，也就是光通量(Luminous flux)即指光源在某單位時間內所發出之光線總數量。一般稱作光束)的單位，簡而言之，流明就是光束照在物體表面的量。

Lumen actually represents the intensity of lights. that is, the luminous flux(Luminous Flux) refers to the unit of the total amount of light emitted by a light source in a unit time, generally referred to as the light beam. In short, lumens is the light beam Amount on the surface of the object.

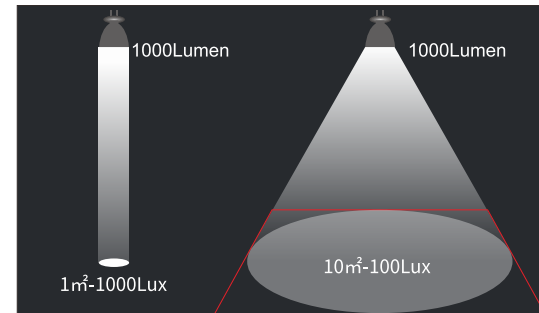

Color Rendering Index 顯色度

顯色度以Ra來表示，天然光的顯色度為100 Ra，顯色度越接近100Ra，我們看到的顏色就越接近物體的自然原色。也就是顏色逼真的程度，顯色度高 我們所看到的顏色也就是較接近自然原色，顯色度低對於顏色的表現較差，所看到的顏色偏差也延遲。

Color rendering is represented by Ra, the color rendering of natural light is 100 Ra, the closer the color rendering is to 100 Ra, the color we see is closer to the natural primary color of the object. Color is realistic. The degree of color rendering is high. The color we see is close to natural primary color, low color rendering, poor performance for color, The color deviation seen is also delayed.

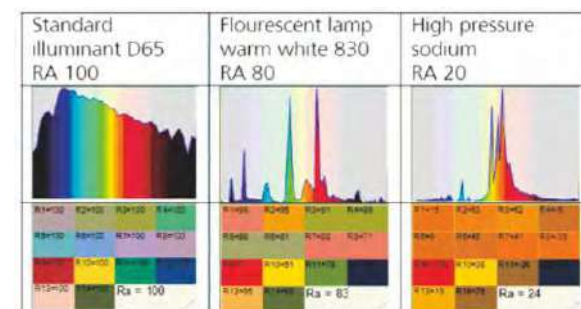

Color Temperature 色溫

色溫及不同色溫應用什麼環境——以絕對溫度 K(kelvin)來表示，色溫度 3000k以下時，光色有偏紅的現象(黃光)，給予一種溫暖、親切、舒適的感覺；色溫度超過 5000k時，顏色則偏向藍光(白光)，給人一種清冷的感覺，令環境變得清淨和寧靜。

通常亞熱帶人較喜歡清冷 4000k以上，而寒帶的人較喜歡4000k以下的色溫度。

Color temperature and what environment is used for different color temperatures-expressed in absolute temperature K (kelvin), when the color temperature is below 3000k, the light color has a reddish phenomenon (yellow light), giving a warm, friendly, comfortable feeling; color temperature exceeds 5000k At this time, the color is biased towards blue light (white light), giving a cool feeling. Make the environment clear and peaceful.

Generally, people in the subtropics prefer cold temperatures above 4000k, while those in the cold regions prefer colors below 4000k.

WB SETTINGS	COLOR TEMPETATURE	LIGHT SOURCES
	10000-15000K	Clear Blue Sky
	6500-8000K	Cloudy Sky / Shade
	6000-7000K	Noon Sunlight
	5500-6500K	Average Daylight
	5000-5500K	Electronic Flash
	4000-5000K	Fluorescent Light
	3000-4000K	Early AM/ Late PM
	2500-3000K	Domestic Lightening
	1000-2000K	Candle Flame



Fire Proof Material 物料防火等級

塑料阻燃等級由 HB, V-2, V-1向V-0逐級遞增。

HB: UL94標準中最低的阻燃等級，要求對於3到13毫米厚的樣品，燃燒速度小於 40毫米每分鐘；小於 3毫米厚的樣品，燃燒速度小於 70毫米每分鐘；或者在 100毫米的標誌前熄滅。

V-2: 對樣品進行兩次 10秒的燃燒測試後，火焰在 30秒內熄滅，可以引燃 30cm下方的藥棉。

V-1: 對樣品進行兩次 10秒的燃燒測試後，火焰在 30秒內熄滅，不能引燃 30cm下方的藥棉。

V-0: 對樣品進行兩次 10秒的燃燒測試後，火焰在 10秒內熄滅，不能有燃燒物掉下。

Plastic flame retardant grades are gradually increased from HB, V-2, V-1 to V-0.

HB: The lowest flame retardant grade in the UL94 standard, Require for 3 to 13mm thick samples with a burning rate of less than 40 mm per minute; less than 3 mm thick samples with a burning rate of less than 70 mm per minute; or stop at 100 mm sign.

V-2: After two 10-second burn tests on the sample, the

flame stops at 30 seconds, would ignite cotton wool below 30cm.

V-1: After two 10-second fire tests on the sample, the flame was at 30 seconds Inside goes out. Would not ignite cotton wool below 30cm.

V-0: After two 10-second burn tests on the sample, the flame stops at 10 seconds. No burning substances should fall off.



Power Factor 功率因數

日常使用的交流電壓是電壓高低不斷地在變化的，理想情況下，電壓和電流相位完全同相，Pf=1。同步下最大的發揮電線的傳輸效率。這情況下用電設備所使用的所有功率叫稱功率。

電器的最大電流瞬間比電網最高電壓的瞬時提前或滯後，那就

會降低電線的效率。由於其不同步，電線內阻造成額外的功率損耗，這部分損耗的功率稱無功率。

The AC voltage used in daily life is constantly changing in voltage, ideally in the following, voltage and current are called in-phase, and PF= 1. Can make the most of the wire transmission efficiency. In this case, all the power used by the electrical equipment is called active power.

The maximum current of the appliance is instantaneously earlier or later than the instant of the maximum voltage of the power grid. Will reduce the efficiency of the wire. Due to its non-synchronization, the internal resistance of the wire causes additional power loss, the power lost in this part is called no power. Therefore, we generally

want to make the electrical equipment as much as possible. The highest voltage is synchronized. The closer the PF is to 1, the more synchronized the wire loss is the more environmentally friendly.

Minimum Allowable Power Factor For Non-Directional LED Lamp With Integrated Driver

Rated Lamp Wattage(LW)	minimum allowable power factor
LW ≤ 5W	0.5
5W < LW ≤ 25W	0.7
LW > 25W	0.9

Minimum Allowable Power Factor For Directional LED Lamp With Integrated Driver

Rated Lamp Wattage(LW)	minimum allowable power factor
LW ≤ 5W	0.5
5W < LW ≤ 25W	0.7
LW > 25W	0.9

information refer to Hong Kong Voluntary Energy Efficiency Labelling for LED lamp-January 2017 EMSD (Electrical and Mechanical Services Department)

Nominal CCT	Target CCT and tolerance(K)	Target DUV and tolerance(K)
2700k	2725 ± 145	0.000 ± 0.006
3000k	3045 ± 175	0.000 ± 0.006
3500k	3465 ± 245	0.000 ± 0.006
4000k	3985 ± 275	0.001 ± 0.006
4500k	4503 ± 243	0.001 ± 0.006
5000k	5026 ± 283	0.002 ± 0.006
5700k	5665 ± 355	0.002 ± 0.006
6500k	6530 ± 510	0.003 ± 0.006
Flexible CCT(2700-6500k)	T* ± ΔT*	D _{uv} ± 0.006

The LED lamp must have one of the rated Correlated Colour Temperatures (CCTs) including 2700K,3000K,3500K,4000K,4500K,5000K,5700K,6500K and flexible CCT consistent with the 7-step chromaticity, quadrangles and Duv tolerances as indicated in Table1. The measured initial CCT and initial DUV shall be within the tolerances of target CCT and target DUV of the selected rated CCT.

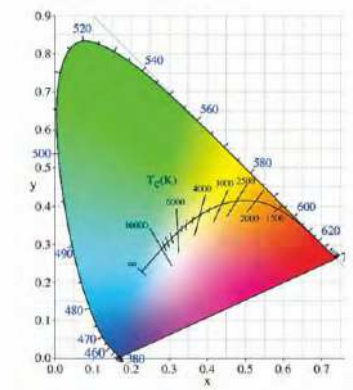

Stroboscopic Suppression 頻閃抑制

理想的光源亮度是鎮流後之直流電壓恆定不變的，這就是理論上的絕對無頻閃。實際上我們平常使用的燈具直流電壓都不會真正的恆定不變，週期的亮度高低變化程度就是頻率。

市面常見LED驅動電路，頻閃深度最大的頻率一般都是100HZ左右。因為PWM高頻是調製在50HZ整流後的電壓上。實際燈具中，任何的頻率上都有一定的頻閃深度(最亮的亮

度和最暗的亮度之差)。那麼，這裡就存在一個頻閃深度最大的時候所對應的頻閃頻率。還有就是最大的頻閃深度值。

頻閃頻率越高對人的影響越小，頻閃深度越小對人的影響越小，總體來說頻閃深度越小對人降低或消除導致視力疲勞的低頻率光，減輕眼睛負擔，關愛眼睛。

Ideal light source brightness is constant, which is absolute no stroboscopic depth. In fact, the brightness of the lamps we usually install will not be truly stable. The degree of change in the brightness within the period is the frequency.

The common LED drive circuit in the market has the stroboscopic depth at frequency 100 HZ or so. This is because PWM high frequency is modulated on the voltage after 50 HZ rectification. In actual lamps, there will be a certain stroboscopic depth at any frequency. (The difference between the greatest brightest and smallest brightness). Well, there would be the strobe frequency corresponding to the maximum stroboscopic depth, that has the biggest strobe depth value.

The higher the strobe frequency, the smaller the impact is on peoples. As a consulsion, the lower the stroboscopic depth can reduce or eliminate low-frequency light vision fatigue that reduces the burden on the eyes and cares about eye health.



LED International standard for chromaticity difference

LED 光源色度差異之國際標準

Chromaticity Tolerances

Quadrangles

— In both ΔCCT and Duv directions

— Approximately equal to 7-step MacAdam ellipses



Light source efficiency lm/w (lumen efficiency)

光源效率 lm/w (流明效率)

光源的效率取決於其所發出的光的流明除以起耗電量所得值LED光亮度，並非似功耗(W)度量，而是以流明輸出(lm)來決定。

iLighting LED 流明效益高，更有歐洲B級能源標籤，保證節電環保。

The efficiency of a light source depends on the lumen of the light it emits divided by the power consumption LED brightness is not similar to wattage (W) measurement, but measured in lumens output (lm) Decide.

iLighting LED Lumen has high lumen efficiency, and it also has obtained European B energy label to ensure power saving and environmental protection.

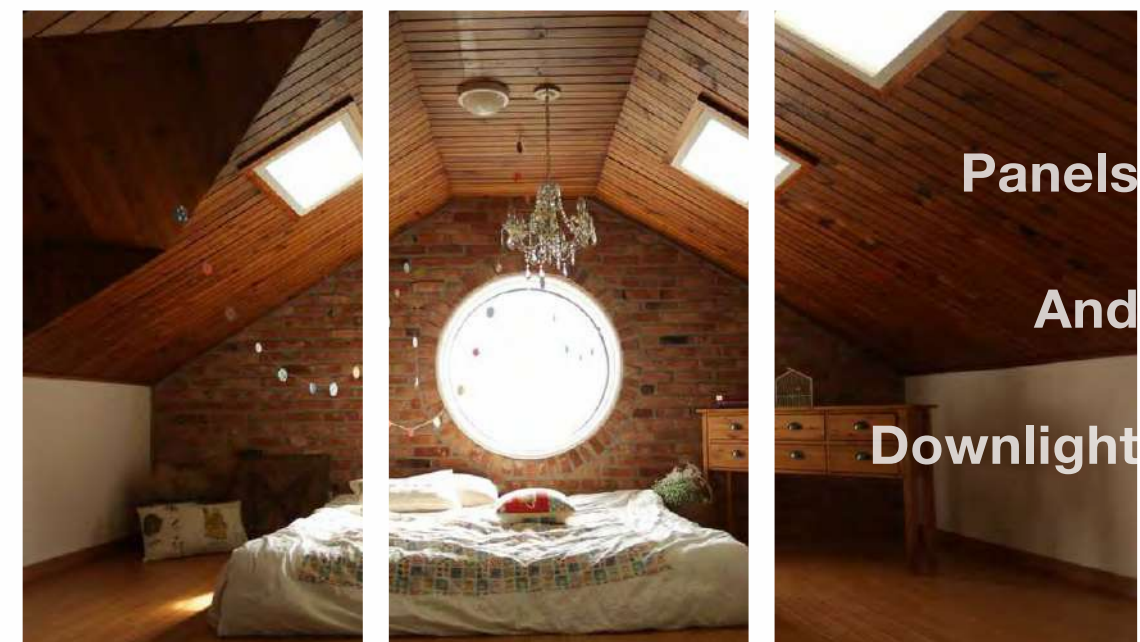
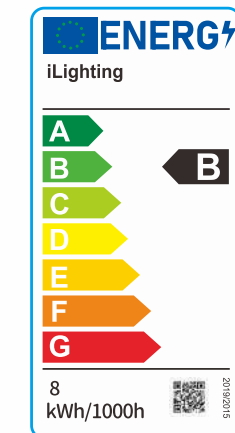

Panel Light

Series Type: PN-N

Features 產品特點 >>

- Material: Acrylic
- High color rendering, durable, large light emitting area
- Uniform light emission without flicker
- UGR<19
- Suitable for installation in recessed ceilings
- Suitable for living room/bedroom/study/porch/commercial lighting

- 材質: 亞克力
- 高顯色性, 經久耐用, 發光面積大
- 發光均勻, 無頻閃
- UGR<19
- 適合安裝在嵌入式天花板中側面發光
- 適用客廳/臥室/書房/玄關/商業照明



Flick Free
(無閃頻)
保護視力

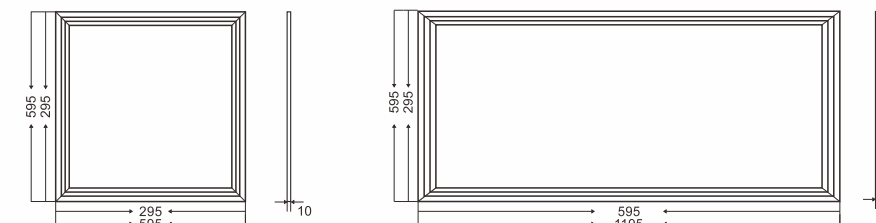

(Unit: mm)

Specification 產品規格 >>

Model 型號	Voltage 電壓 (V)	Power 功率 (W)	Lumen Output 輸出流明 (Lm/W)	Color Rendering 顯色度 (CRI)	Colour Temp 色溫 (K)	Life Time 壽命 (H)	Beam Angle 光束角 (°)	Working temperature 工作溫度 (°C)	Size 尺寸 (mm)
PL-PN3030-N128A	100~240	9	120	>80	3000/4000/6500	50000	180	-20~45	295*295
PL-PN6060-N128A	100~240	36	120	>80	3000/4000/6500	50000	180	-20~45	595*595
PL-PN3060-N128A	100~240	18	120	>80	3000/4000/6500	50000	180	-20~45	295*595
PL-PN60120-N128A	100~240	72	120	>80	3000/4000/6500	50000	180	-20~45	595*1195

- Light efficiency (lm/W), Power (W), Color Rendering Index (CRI), Size Can be customized according to customer needs
- Our Standard Power factor (PF) > 0.9 and Total harmonic index THD < 15%, According to customer requirements can produce a lower THD < 10%
- This type of certification is issued by a government-approved laboratory for Safety certification, Fire testing, Restriction of Hazardous Substances (RoHS), Photobiological safety of lamps and lamp systems. (an Exemption Group) and other test certifications to ensure product quality

- 光效 (lm/W)、功率 (W)、顯色指數 (CRI)、長度, 可根據客戶需求定制
- 此型號標準之功率因素 (PF) > 0.9, 總諧波指數 THD < 15%, 可按客戶需要生產低總諧波指數 < 10%
- 此型號認證由可實驗室發出之安全認證消防測試, 環保物料 (RoHS), 光生物安全為 Exemption Group 及其它測試, 保證客戶使用更安心滿意

Panel Light

面板燈

Panel Light

Series Type: PN-T

Features 產品特點 >>

- Material: Aluminum 6063+PC
- High color rendering, durable, large light emitting area
- Uniform light emission without flicker
- LED surface mounted front light
- Suitable for living room/bedroom/study/porch/commercial lighting

- 材質: 鋁6063+PC
- 高顯色性, 經久耐用, 發光面積大
- 發光均勻, 無頻閃
- LED明裝正面發光
- 適用客廳/臥室/書房/玄關/商業照明

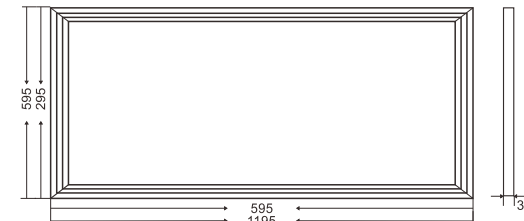
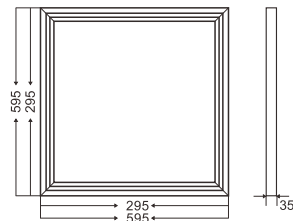

(Unit : mm)

Specification 產品規格 >>

Model 型號	Voltage 電壓 (V)	Power 功率 (W)	Lumen Output 輸出流明 (Lm/W)	Color Rendering 顯色度 (CRI)	Colour Temp 色溫 (K)	Life Time 壽命 (H)	Beam Angle 光束角 (°)	Working temperature 工作溫度 (°C)	Size 尺寸 (mm)
PL-PN3030-T128A	100~240	9	120	>80	3000/4000/6500	50000	180	-20~45	295*295
PL-PN6060-T128A	100~240	36	120	>80	3000/4000/6500	50000	180	-20~45	595*595
PL-PN3060-T128A	100~240	18	120	>80	3000/4000/6500	50000	180	-20~45	295*595
PL-PN60120-T128A	100~240	72	120	>80	3000/4000/6500	50000	180	-20~45	595*1195

- Light efficiency (lm/W), Power (W), Color Rendering Index (CRI), Size Can be customized according to customer needs
- Our Standard Power factor (PF) > 0.9 and Total harmonic index THD < 15%, According to customer requirements can produce a lower THD < 10%
- This type of certification is issued by a government-approved laboratory for Safety certification, Fire testing, Restriction of Hazardous Substances (RoHS), Photobiological safety of lamps and lamp systems. (an Exemption Group) and other test certifications to ensure product quality

- 光效 (lm/W)、功率 (W)、顯色指數 (CRI)、長度, 可根據客戶需求定制
- 此型號標準之功率因素 (PF) > 0.9, 總諧波指數 THD < 15%, 可按客戶需要生產低總諧波指數 < 10%
- 此型號認證由可實驗室發出之安全認證消防測試, 環保物料 (RoHS), 光生物安全為 Exemption Group 及其它測試, 保證客戶使用更安心滿意

Panel Light

Series Type: PN-M

Features 產品特點 >>

- Material: Aluminum 6063+PC high transparency mask, soft light
- High color rendering, durable, large light emitting area
- Uniform light emission without flicker
- Microwave controlled internal sensor, lighting delay/exit time: 25s
- Sensor detection distance is 6-8 meters
- Full lumen in active mode, 30% in standby mode
- Suitable for living room/bedroom/study/porch/commercial lighting

- 材質: 鋁6063+PC高透面罩, 光線柔和
- 高顯色性, 經久耐用, 發光面積大
- 發光均勻, 無頻閃
- 微波控制內部傳感器, 照明延時/退出時間: 25s
- 傳感器檢測距離為6-8米
- 在激活模式下全流明, 在待機模式下為30%
- 適用客廳/臥室/書房/玄關/商業照明

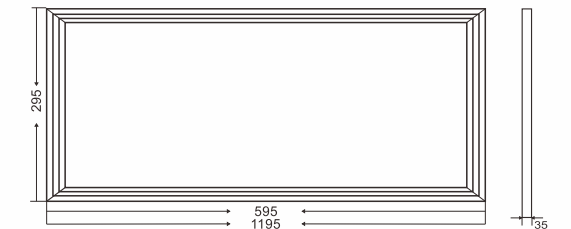
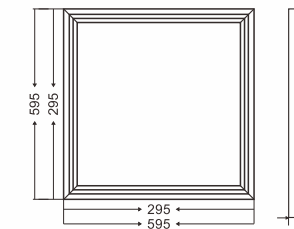

(Unit : mm)

Specification 產品規格 >>

Model 型號	Voltage 電壓 (V)	Power 功率 (W)	Lumen Output 輸出流明 (Lm/W)	Color Rendering 顯色度 (CRI)	Colour Temp 色溫 (K)	Life Time 壽命 (H)	Beam Angle 光束角 (°)	Working temperature 工作溫度 (°C)	Size 尺寸 (mm)
PL-PN3030-M128A	100~240	9	120	>80	3000/4000/6500	50000	180	-20~45	295*295
PL-PN6060-M128A	100~240	36	120	>80	3000/4000/6500	50000	180	-20~45	595*595
PL-PN3060-M128A	100~240	18	120	>80	3000/4000/6500	50000	180	-20~45	295*595
PL-PN60120-M128A	100~240	72	120	>80	3000/4000/6500	50000	180	-20~45	295*1195

- Light efficiency (lm/W), Power (W), Color Rendering Index (CRI), Size Can be customized according to customer needs
- Our Standard Power factor (PF) > 0.9 and Total harmonic index THD < 15%, According to customer requirements can produce a lower THD < 10%
- This type of certification is issued by a government-approved laboratory for Safety certification, Fire testing, Restriction of Hazardous Substances (RoHS), Photobiological safety of lamps and lamp systems. (an Exemption Group) and other test certifications to ensure product quality

- 光效 (lm/W)、功率 (W)、顯色指數 (CRI)、長度, 可根據客戶需求定制
- 此型號標準之功率因素 (PF) > 0.9, 總諧波指數 THD < 15%, 可按客戶需要生產低總諧波指數 < 10%
- 此型號認證由可實驗室發出之安全認證消防測試, 環保物料 (RoHS), 光生物安全為 Exemption Group 及其它測試, 保證客戶使用更安心滿意

Panel Light

Series Type: PN-F

Features 產品特點 >>

- Material: Aluminum 6063+PC high transparency mask, soft light
- High color rendering, durable, large light emitting area
- Uniform light emission without flicker
- LED surface mounted front light
- Suitable for living room/bedroom/study/porch/commercial lighting

- 材質: 鋁6063+PC高透面罩, 光線柔和
- 高顯色性, 經久耐用, 發光面積大
- 發光均勻, 無頻閃
- LED明裝正面發光
- 適用客廳/臥室/書房/玄關/商業照明



Flick Free
(無閃頻)
保護視力

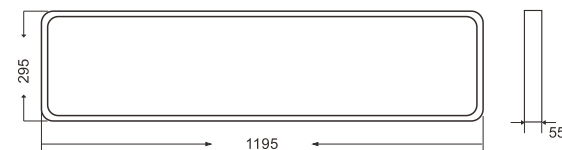

(Unit : mm)

Specification 產品規格 >>

Model 型號	Voltage 電壓	Power 功率	Lumen Output 輸出流明	Color Rendering 顯色度	Colour Temp 色溫	Life Time 壽命	Beam Angle 光束角	Working temperature 工作溫度	Size 尺寸
	(V)	(W)	(Lm/W)	(CRI)	(K)	(H)	(°)	(°C)	(mm)
PL-PN30120-F108A	100-240	10	100	>80	3000/4000/6500	50000	180	-20~45	295*1195

- Light efficiency (lm/W), Power (W), Color Rendering Index (CRI), Size Can be customized according to customer needs
- Our Standard Power factor (PF) > 0.9 and Total harmonic index THD < 15%, According to customer requirements can produce a lower THD < 10%
- This type of certification is issued by a government-approved laboratory for Safety certification, Fire testing, Restriction of Hazardous Substances (RoHS), Photobiological safety of lamps and lamp systems. (an Exemption Group) and other test certifications to ensure product quality

- 光效 (lm/W)、功率 (W)、顯色指數 (CRI)、長度, 可根據客戶需求定制
- 此型號標準之功率因素 (PF) > 0.9, 總諧波指數 THD < 15%, 可按客戶需要生產低總諧波指數 < 10%
- 此型號認證由可實驗室發出之安全認證消防測試, 環保物料 (RoHS), 光生物安全為 Exemption Group 及其它測試, 保證客戶使用更安心滿意

Panel Light

Series Type: PN-C

Features 產品特點 >>

- Material: Aluminum 6063+PS high transparency mask, soft light
- High color rendering, durable, large light emitting area
- Uniform light emission without flicker
- LED surface mounted side light
- Suitable for living room/bedroom/study/porch/commercial lighting

- 材質: 鋁6063+PS高透面罩, 光線柔和
- 高顯色性, 經久耐用, 發光面積大
- 發光均勻, 無頻閃
- LED明裝側面發光
- 適用客廳/臥室/書房/玄關/商業照明



Flick Free
(無閃頻)
保護視力

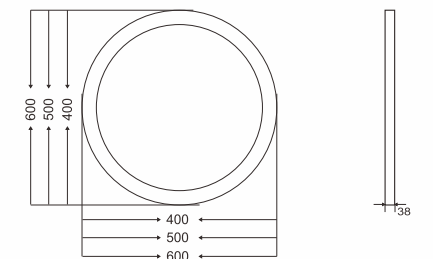

(Unit : mm)

Specification 產品規格 >>

Model 型號	Voltage 電壓	Power 功率	Lumen Output 輸出流明	Color Rendering 顯色度	Colour Temp 色溫	Life Time 壽命	Beam Angle 光束角	Working temperature 工作溫度	Size 尺寸
	(V)	(W)	(Lm/W)	(CRI)	(K)	(H)	(°)	(°C)	(mm)
PL-PN400-C108A	100~240	36	100	>80	3000/4000/6000	50000	180	-20~45	Φ400*38
PL-PN500-C108A	100~240	40	100	>80	3000/4000/6000	50000	180	-20~45	Φ500*38
PL-PN600-C108A	100~240	48	100	>80	3000/4000/6000	50000	180	-20~45	Φ600*38

- Light efficiency (lm/W), Power (W), Color Rendering Index (CRI), Size Can be customized according to customer needs
- Our Standard Power factor (PF) > 0.9 and Total harmonic index THD < 15%, According to customer requirements can produce a lower THD < 10%
- This type of certification is issued by a government-approved laboratory for Safety certification, Fire testing, Restriction of Hazardous Substances (RoHS), Photobiological safety of lamps and lamp systems. (an Exemption Group) and other test certifications to ensure product quality

- 光效 (lm/W)、功率 (W)、顯色指數 (CRI)、長度, 可根據客戶需求定制
- 此型號標準之功率因素 (PF) > 0.9, 總諧波指數 THD < 15%, 可按客戶需要生產低總諧波指數 < 10%
- 此型號認證由可實驗室發出之安全認證消防測試, 環保物料 (RoHS), 光生物安全為 Exemption Group 及其它測試, 保證客戶使用更安心滿意

Panel Light

Series Type: PN-C

Features 產品特點 >>

- Material: Aluminum 6063+PS high transparency mask, soft light
- High color rendering, durable, large light emitting area
- Uniform light emission without flicker
- LED surface mounted side light
- Suitable for living room/bedroom/study/porch/commercial lighting

- 材質: 鋁6063+PS高透面罩, 光線柔和
- 高顯色性, 經久耐用, 發光面積大
- 發光均勻, 無頻閃
- LED明裝側面發光
- 適用客廳/臥室/書房/玄關/商業照明

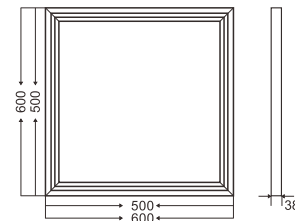

(Unit: mm)

Specification 產品規格 >>

Model 型號	Voltage 電壓 (V)	Power 功率 (W)	Lumen Output 輸出流明 (Lm/W)	Color Rendering 顯色度 (CRI)	Colour Temp 色溫 (K)	Life Time 壽命 (H)	Beam Angle 光束角 (°)	Working temperature 工作溫度 (°C)	Size 尺寸 (mm)
PL-PN30120-C108A	100~240	40	100	>80	3000/4000/6000	50000	180	-20~45	300*1200*38
PL-PN5050-C108A	100~240	48	100	>80	3000/4000/6000	50000	180	-20~45	500*500*38
PL-PN6060-C108A	100~240	48	100	>80	3000/4000/6000	50000	180	-20~45	600*600*38

- Light efficiency (lm/W), Power (W), Color Rendering Index (CRI), Size Can be customized according to customer needs
- Our Standard Power factor (PF) > 0.9 and Total harmonic index THD < 15%, According to customer requirements can produce a lower THD < 10%
- This type of certification is issued by a government-approved laboratory for Safety certification, Fire testing, Restriction of Hazardous Substances (RoHS), Photobiological safety of lamps and lamp systems. (an Exemption Group) and other test certifications to ensure product quality
- 光效 (lm/W)、功率 (W)、顯色指數 (CRI)、長度, 可根據客戶需求定制
- 此型號標準之功率因素 (PF) > 0.9, 總諧波指數 THD < 15%, 可按客戶需要生產低總諧波指數 < 10%
- 此型號認證由可實驗室發出之安全認證消防測試, 環保物料 (RoHS), 光生物安全為 Exemption Group 及其它測試, 保證客戶使用更安心滿意

Panel Light

Series Type: PN-Z

Features 產品特點 >>

- Material: Aluminum 6063+PS high transparency mask, soft light
- High color rendering, durable, large light emitting area
- Uniform light emission without flicker
- LED surface mounted front light
- Suitable for living room/bedroom/study/porch/commercial lighting

- 材質: 鋁6063+PS高透面罩, 光線柔和
- 高顯色性, 經久耐用, 發光面積大
- 發光均勻, 無頻閃
- LED明裝正面發光
- 適用客廳/臥室/書房/玄關/商業照明

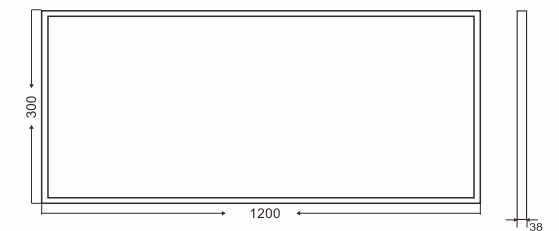

(Unit: mm)

Specification 產品規格 >>

Model 型號	Voltage 電壓 (V)	Power 功率 (W)	Lumen Output 輸出流明 (Lm/W)	Color Rendering 顯色度 (CRI)	Colour Temp 色溫 (K)	Life Time 壽命 (H)	Beam Angle 光束角 (°)	Working temperature 工作溫度 (°C)	Size 尺寸 (mm)
PL-PN30120-Z108A	100~240	40	100	>80	3000/4000/6000	50000	180	-20~45	300*1200*38
PL-PN30120-Z108A	100~240	54	100	>80	3000/4000/6000	50000	180	-20~45	300*1200*38

- Light efficiency (lm/W), Power (W), Color Rendering Index (CRI), Size Can be customized according to customer needs
- Our Standard Power factor (PF) > 0.9 and Total harmonic index THD < 15%, According to customer requirements can produce a lower THD < 10%
- This type of certification is issued by a government-approved laboratory for Safety certification, Fire testing, Restriction of Hazardous Substances (RoHS), Photobiological safety of lamps and lamp systems. (an Exemption Group) and other test certifications to ensure product quality
- 光效 (lm/W)、功率 (W)、顯色指數 (CRI)、長度, 可根據客戶需求定制
- 此型號標準之功率因素 (PF) > 0.9, 總諧波指數 THD < 15%, 可按客戶需要生產低總諧波指數 < 10%
- 此型號認證由可實驗室發出之安全認證消防測試, 環保物料 (RoHS), 光生物安全為 Exemption Group 及其它測試, 保證客戶使用更安心滿意

Panel Light

Series Type: PN-JS

Features 產品特點 >>

- Material: Aluminum 6063+PC
- High color rendering, durable, large light emitting area
- Uniform light emission without flicker
- LED surface mounted directional light
- Professional Classroom Blackboard Lamp

- E材質: 鋁6063+PC
- 高顯色性, 經久耐用, 發光面積大
- 發光均勻, 無頻閃
- LED明裝定向發光
- 專業級教室黑板燈

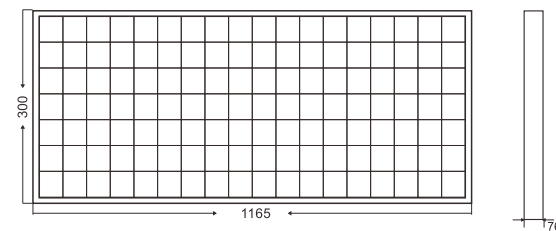

(Unit : mm)

Specification 產品規格 >>

Model 型號	Voltage 電壓	Power 功率	Lumen Output 輸出流明	Color Rendering 顯色度	Colour Temp 色溫	Life Time 壽命	Beam Angle 光束角	Working temperature 工作溫度	Size 尺寸
	(V)	(W)	(Lm/W)	(CRI)	(K)	(H)	(°)	(°C)	(mm)
PL-PN30120-JS108A	100~240	40	100	>80	5000	50000	180	-20~45	1165*300*76

- Light efficiency (lm/W), Power (W), Color Rendering Index (CRI), Size Can be customized according to customer needs
- Our Standard Power factor (PF) > 0.9 and Total harmonic index THD < 15%, According to customer requirements can produce a lower THD < 10%
- This type of certification is issued by a government-approved laboratory for Safety certification, Fire testing, Restriction of Hazardous Substances(RoHS), Photobiological safety of lamps and lamp systems.(an Exemption Group) and other test certifications to ensure product quality

- 光效 (lm/W)、功率 (W)、顯色指數 (CRI)、長度, 可根據客戶需求定制
- 此型號標準之功率因素 (PF) > 0.9, 總諧波指數 THD < 15%, 可按客戶需要生產低總諧波指數 < 10%
- 此型號認證由可實驗室發出之安全認證消防測試, 環保物料 (RoHS), 光生物安全為 Exemption Group 及其它測試, 保證客戶使用更安心滿意

Panel Light

Series Type: PN-XD

Features 產品特點 >>

- High-transparent acrylic lampshade with even light transmission
- High color rendering, durable, large light emitting area
- Uniform light emission without flicker
- Impact resistant and flame retardant, easy to clean
- Suitable for living room/bedroom/study/porch/commercial lighting

- 高透亚克力燈罩, 透光均勻
- 高顯色性, 經久耐用, 發光面積大
- 發光均勻, 無頻閃
- 耐衝擊防阻燃, 易清潔
- 適用客廳/臥室/書房/玄關/商業照明

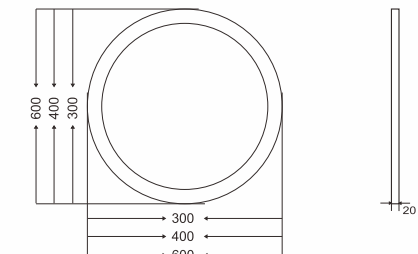

(Unit : mm)

Specification 產品規格 >>

Model 型號	Voltage 電壓	Power 功率	Lumen Output 輸出流明	Color Rendering 顯色度	Colour Temp 色溫	Life Time 壽命	Beam Angle 光束角	Working temperature 工作溫度	Size 尺寸
	(V)	(W)	(Lm/W)	(CRI)	(K)	(H)	(°)	(°C)	(mm)
PL-PN300-XD108A	100~240	24	100	>80	3000/4000/6000	50000	180	-20~45	Φ300*20
PL-PN400-XD108A	100~240	36	100	>80	3000/4000/6000	50000	180	-20~45	Φ400*20
PL-PN600-XD108A	100~240	48	100	>80	3000/4000/6000	50000	180	-20~45	Φ600*20

- Light efficiency (lm/W), Power (W), Color Rendering Index (CRI), Size Can be customized according to customer needs
- Our Standard Power factor (PF) > 0.9 and Total harmonic index THD < 15%, According to customer requirements can produce a lower THD < 10%
- This type of certification is issued by a government-approved laboratory for Safety certification, Fire testing, Restriction of Hazardous Substances(RoHS), Photobiological safety of lamps and lamp systems.(an Exemption Group) and other test certifications to ensure product quality

- 光效 (lm/W)、功率 (W)、顯色指數 (CRI)、長度, 可根據客戶需求定制
- 此型號標準之功率因素 (PF) > 0.9, 總諧波指數 THD < 15%, 可按客戶需要生產低總諧波指數 < 10%
- 此型號認證由可實驗室發出之安全認證消防測試, 環保物料 (RoHS), 光生物安全為 Exemption Group 及其它測試, 保證客戶使用更安心滿意

Panel Light

Series Type: PN-DX

Features 產品特點 >>

- Material: Aluminum 6063+PS high transparency mask, soft light
- High color rendering, durable, large light emitting area
- Uniform light emission without flicker
- Ring LED hanging wire iron frame
- Suitable for living room/bedroom/study/porch/commercial lighting

- 材質: 鋁6063+PS高透面罩, 光線柔和
- 高顯色性, 經久耐用, 發光面積大
- 發光均勻, 無頻閃
- 圓環LED吊線鐵藝邊框
- 適用客廳/臥室/書房/玄關/商業照明

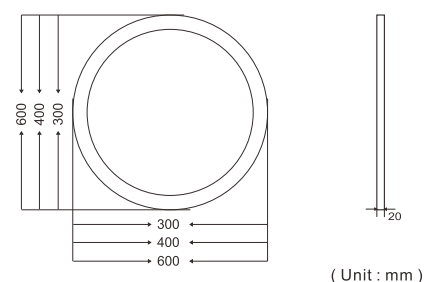

Specification 產品規格 >>

Model 型號	Voltage 電壓 (V)	Power 功率 (W)	Lumen Output 輸出流明 (Lm/W)	Color Rendering 顯色度 (CRI)	Colour Temp 色溫 (K)	Life Time 壽命 (H)	Beam Angle 光束角 (°)	Working temperature 工作溫度 (°C)	Size 尺寸 (mm)
PL-PN-300-DX108A	100~240	24	100	>80	3000/4000/6000	50000	180	-20~45	Φ300*20
PL-PN-400-DX108A	100~240	36	100	>80	3000/4000/6000	50000	180	-20~45	Φ400*20
PL-PN-600-DX108A	100~240	48	100	>80	3000/4000/6000	50000	180	-20~45	Φ600*20

- Light efficiency (lm/W), Power (W), Color Rendering Index (CRI), Size Can be customized according to customer needs
- Our Standard Power factor (PF) > 0.9 and Total harmonic index THD < 15%, According to customer requirements can produce a lower THD < 10%
- This type of certification is issued by a government-approved laboratory for Safety certification, Fire testing, Restriction of Hazardous Substances (RoHS), Photobiological safety of lamps and lamp systems, (an Exemption Group) and other test certifications to ensure product quality

- 光效 (lm/W)、功率 (W)、顯色指數 (CRI)、長度, 可根據客戶需求定制
- 此型號標準之功率因素 (PF) > 0.9, 總諧波指數 THD < 15%, 可按客戶需要生產低總諧波指數 < 10%
- 此型號認證由可實驗室發出之安全認證消防測試, 環保物料 (RoHS), 光生物安全為 Exemption Group 及其它測試, 保證客戶使用更安心滿意

Anti Glare Panel Light

Series Type: PN-A

Features 產品特點 >>

- Good sealing performance, dust and insect proof, high color rendering index and bright color
- UGR<19 prism plate, anti-glare, no dark area, uniform light, bright, soft, comfortable and not dazzling
- Good heat dissipation structure design can quickly output heat
- Ultra light and ultra-thin, easy to install, embedded installation or ceiling installation, flexible use of space
- Suitable for living room/bedroom/study/porch/commercial lighting

- 密封性能好, 防塵防蟲, 顯色指數高, 色彩鮮艷
- UGR<19 稜鏡板, 防眩光, 無暗區, 光線均勻, 明亮柔和, 舒適不刺眼
- 良好的散熱結構設計能快速輸出熱量
- 超輕超薄, 安裝方便, 嵌入式安裝或吸頂安裝, 靈活利用空間
- 適用客廳/臥室/書房/玄關/商業照明

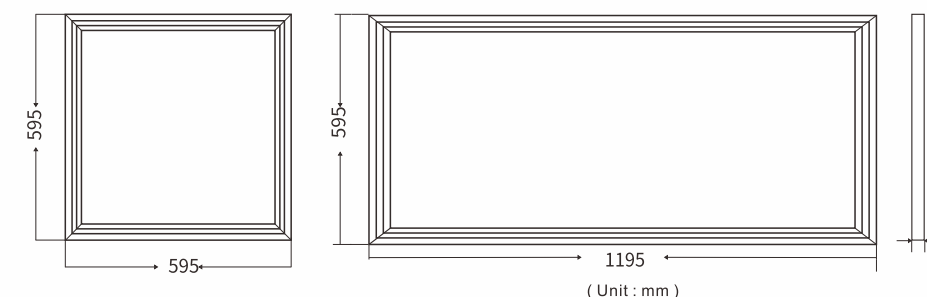

Specification 產品規格 >>

Model 型號	Voltage 電壓 (V)	Power 功率 (W)	Lumen Output 輸出流明 (Lm/W)	Color Rendering 顯色度 (CRI)	Colour Temp 色溫 (K)	Life Time 壽命 (H)	Beam Angle 光束角 (°)	Prism UGR 稜鏡板	Working temperature 工作溫度 (°C)	Size 尺寸 (mm)
PL-PN6060-A108A	220-240	36	100	>80	3000/4000/6500	50000	110	<19 anti-glare	-20~45	595*595
PL-PN60120-A108A	220-240	54	100	>80	3000/4000/6500	50000	110	<19 anti-glare	-20~45	595*1195

- Light efficiency (lm/W), Power (W), Color Rendering Index (CRI), Size Can be customized according to customer needs
- Our Standard Power factor (PF) > 0.9 and Total harmonic index THD < 15%, According to customer requirements can produce a lower THD < 10%
- This type of certification is issued by a government-approved laboratory for Safety certification, Fire testing, Restriction of Hazardous Substances (RoHS), Photobiological safety of lamps and lamp systems, (an Exemption Group) and other test certifications to ensure product quality

- 光效 (lm/W)、功率 (W)、顯色指數 (CRI)、長度, 可根據客戶需求定制
- 此型號標準之功率因素 (PF) > 0.9, 總諧波指數 THD < 15%, 可按客戶需要生產低總諧波指數 < 10%
- 此型號認證由可實驗室發出之安全認證消防測試, 環保物料 (RoHS), 光生物安全為 Exemption Group 及其它測試, 保證客戶使用更安心滿意

Panel Light

Series Type: PN-PN-T-D

Features 產品特點 >>

- Material: Aluminum 6063+PS high transparency mask, soft light
- Uniform light emission by using optical Polycarbonate
- High light efficiency 100 lm/w
- Dual Color(3000k-6000k)
- Intelligent Remote Control Switch
- Suitable for installation in Recessed Ceilings
- Edge-lite LED panels for office& commercial application

- 材質: 鋁6063+PS高透面罩, 光線柔和
- 產品使用光學聚碳酸酯, 發光均勻
- 高光效100lm/w
- 雙色 (3000k-6000k)
- 智能遙控開關
- 適合安裝在嵌入式天花板中
- 邊緣低熱LED面板, 適用於用於辦公室和商業應用中



Flick Free
(無閃頻)
保護視力

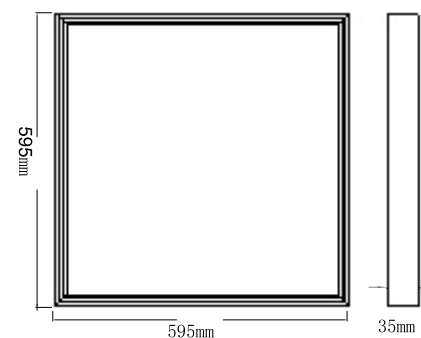
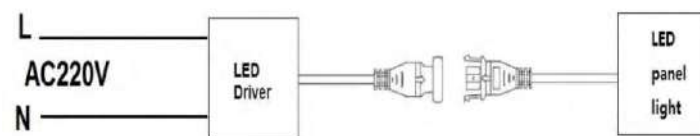

(Unit : mm)

Specification 產品規格 >>

Model 型號	Voltage 電壓	Power 功率	Lumen Output 輸出流明	Color Rendering 顯色度	Colour Temp 色溫	Life Time 壽命	Beam Angle 光束角	Working temperature 工作溫度	Size 尺寸
	(V)	(W)	(Lm/W)	(CRI)	(K)	(H)	(°)	(°C)	(mm)
PL-PN6060-T-D	85-265	30	100	>80	3000/4000/6000	50000	120	-20~45	595*595*35

- Light efficiency (lm/W), Power (W), Color Rendering Index (CRI), Size Can be customized according to customer needs
- Our Standard Power factor (PF) > 0.9 and Total harmonic index THD < 15%, According to customer requirements can produce a lower THD < 10%
- This type of certification is issued by a government-approved laboratory for Safety certification, Fire testing, Restriction of Hazardous Substances(RoHS), Photobiological safety of lamps and lamp systems.(an Exemption Group) and other test certifications to ensure product quality

- 光效 (lm/W)、功率 (W)、顯色指數 (CRI)、長度, 可根據客戶需求定制
- 此型號標準之功率因素 (PF) > 0.9, 總諧波指數 THD < 15%, 可按客戶需要生產低總諧波指數 < 10%
- 此型號認證由可實驗室發出之安全認證消防測試, 環保物料 (RoHS), 光生物安全為 Exemption Group 及其它測試, 保證客戶使用更安心滿意



LED Circular Lamp

LED 圓盤燈

LED Circular Lamp

Series Type: ILR-A

Features 產品特點 >>

- Material: Aluminium+PC Cover
- Uniform light emission
- High luminous output & Low power consumption
- SPM Design – power circuit protection to cut off individual LEDs when mal-functioned
- Easy and firm installation

- 材質: 鋁+PC蓋
- 發光均勻
- 高發光輸出和低功耗
- SPM設計-電源電路保護功能可在故障時切斷單個LED
- 輕鬆而牢固的安裝

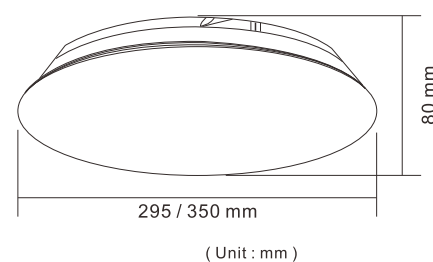

Specification 產品規格 >>

Model 型號	Voltage 電壓 (V)	Power 功率 (W)	Lumen Output 輸出流明 (Lm/W)	Color Rendering 顯色度 (CRI)	Colour Temp 色溫 (K)	Life Time 壽命 (H)	Beam Angle 光束角 (°)	Working temperature 工作溫度 (°C)	Size 尺寸 (mm)
ILR-A16-H108B	85-265	16	100	>80	2700~6500	50000	180	-20~45	Φ295*80
ILR-A18-N108B	85-265	18	100	>80	2700~6500	50000	180	-20~45	Φ350*80

- Light efficiency (lm/W), Power (W), Color Rendering Index (CRI), Size Can be customized according to customer needs
- Our Standard Power factor (PF) > 0.9 and Total harmonic index THD < 15%, According to customer requirements can produce a lower THD < 10%
- This type of certification is issued by a government-approved laboratory for Safety certification, Fire testing, Restriction of Hazardous Substances (RoHS), Photobiological safety of lamps and lamp systems. (an Exemption Group) and other test certifications to ensure product quality

- 光效 (lm/W)、功率 (W)、顯色指數 (CRI)、長度, 可根據客戶需求定制
- 此型號標準之功率因素 (PF) > 0.9, 總諧波指數 THD < 15%, 可按客戶需要生產低總諧波指數 < 10%
- 此型號認證由可實驗室發出之安全認證消防測試, 環保物料 (RoHS), 光生物安全為 Exemption Group 及其它測試, 保證客戶使用更安心滿意

LED Circular Lamp

Series Type: ILR-T-H

Features 產品特點 >>

- Material: Aluminium+PC Cover
- Uniform light emission
- High luminous output & Low power consumption
- SPM Design – power circuit protection to cut off individual LEDs when mal-functioned
- Easy and firm installation

- 材質: 鋁+PC蓋
- 發光均勻
- 高發光輸出和低功耗
- SPM設計-電源電路保護功能可在故障時切斷單個LED
- 輕鬆而牢固的安裝

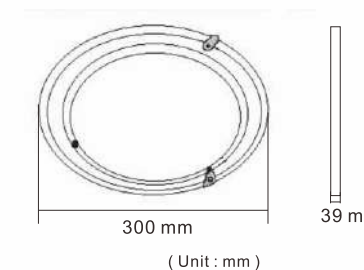

Specification 產品規格 >>

Model 型號	Voltage 電壓 (V)	Power 功率 (W)	Lumen Output 輸出流明 (Lm/W)	Color Rendering 顯色度 (CRI)	Colour Temp 色溫 (K)	Life Time 壽命 (H)	Beam Angle 光束角 (°)	Working temperature 工作溫度 (°C)	Size 尺寸 (mm)
ILR-T08-H108	85-265	8	100	>80	2700~6500	50000	180	-20~45	Φ300*39

- Light efficiency (lm/W), Power (W), Color Rendering Index (CRI), Size Can be customized according to customer needs
- Our Standard Power factor (PF) > 0.9 and Total harmonic index THD < 15%, According to customer requirements can produce a lower THD < 10%
- This type of certification is issued by a government-approved laboratory for Safety certification, Fire testing, Restriction of Hazardous Substances (RoHS), Photobiological safety of lamps and lamp systems. (an Exemption Group) and other test certifications to ensure product quality

- 光效 (lm/W)、功率 (W)、顯色指數 (CRI)、長度, 可根據客戶需求定制
- 此型號標準之功率因素 (PF) > 0.9, 總諧波指數 THD < 15%, 可按客戶需要生產低總諧波指數 < 10%
- 此型號認證由可實驗室發出之安全認證消防測試, 環保物料 (RoHS), 光生物安全為 Exemption Group 及其它測試, 保證客戶使用更安心滿意

LED Circular Lamp

Series Type: ILR-A-S

Features 產品特點 >>

- Material: Aluminum 6063
- Energy saving: more than 70% energy saving than traditional downlight
- Uniform light emission without flicker
- Lightweight and easy to install
- White external frame can be integrated into any environment
- Designed for commercial and residential use in recessed spaces

- 材質: 鋁6063
- 節能: 比傳統筒燈節能70%以上
- 發光均勻, 無頻閃
- 質量輕, 方便安裝
- 白色外部框架可融入任何環境
- 專為商業和住宅嵌入式使用而設計

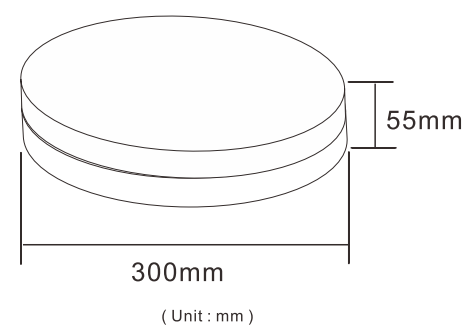

Specification 產品規格 >>

Model 型號	Voltage 電壓	Power 功率	Lumen Output 輸出流明	Color Rendering 顯色度	Colour Temp 色溫	Life Time 壽命	Beam Angle 光束角	Working temperature 工作溫度	Size 尺寸
	(V)	(W)	(Lm/W)	(CRI)	(K)	(H)	(°)	(°C)	(mm)
ILR-A08-S128B	85-265	8	120	>80	6000	30000	180	-20~45	Φ300*55

- Light efficiency (lm/W), Power (W), Color Rendering Index (CRI), Size Can be customized according to customer needs
- Our Standard Power factor (PF) > 0.9 and Total harmonic index THD < 15%, According to customer requirements can produce a lower THD < 10%
- This type of certification is issued by a government-approved laboratory for Safety certification, Fire testing, Restriction of Hazardous Substances (RoHS), Photobiological safety of lamps and lamp systems. (an Exemption Group) and other test certifications to ensure product quality

- 光效 (lm/W)、功率 (W)、顯色指數 (CRI)、長度, 可根據客戶需求定制
- 此型號標準之功率因素 (PF) > 0.9, 總諧波指數 THD < 15%, 可按客戶需要生產低總諧波指數 < 10%
- 此型號認證由可實驗室發出之安全認證消防測試, 環保物料 (RoHS), 光生物安全為 Exemption Group 及其它測試, 保證客戶使用更安心滿意

LED Circular Lamp

Series Type: ILR-A

Features 產品特點 >>

- Material: Aluminium + PMMA
- High quality LED, uniform light, no dark area
- High luminous output & Low power consumption
- Ceiling luminaire surface mounted
- Suitable for indoor applications

- 資料: 鋁+PMMA
- 高品質LED, 光線均勻, 無暗區
- 高發光輸出和低功耗
- 吸頂燈具明裝
- 適用於室內應用

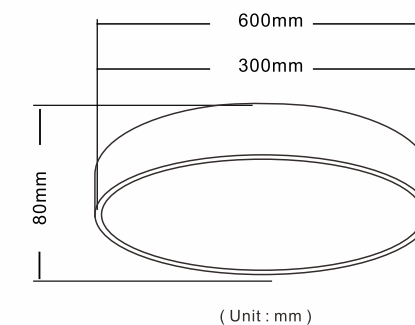

Specification 產品規格 >>

Model 型號	Voltage 電壓	Power 功率	Lumen Output 輸出流明	Color Rendering 顯色度	Colour Temp 色溫	Life Time 壽命	Beam Angle 光束角	Working temperature 工作溫度	Size 尺寸
	(V)	(W)	(Lm/W)	(CRI)	(K)	(H)	(°)	(°C)	(mm)
ILR-A13-H128B	220-240	15	120	>80	2700~6500	50000	180	-20~45	Φ300*80
ILR-A18-N128B	220-240	32	120	>80	2700~6500	50000	180	-20~45	Φ600*80

- Light efficiency (lm/W), Power (W), Color Rendering Index (CRI), Size Can be customized according to customer needs
- Our Standard Power factor (PF) > 0.9 and Total harmonic index THD < 15%, According to customer requirements can produce a lower THD < 10%
- This type of certification is issued by a government-approved laboratory for Safety certification, Fire testing, Restriction of Hazardous Substances (RoHS), Photobiological safety of lamps and lamp systems. (an Exemption Group) and other test certifications to ensure product quality

- 光效 (lm/W)、功率 (W)、顯色指數 (CRI)、長度, 可根據客戶需求定制
- 此型號標準之功率因素 (PF) > 0.9, 總諧波指數 THD < 15%, 可按客戶需要生產低總諧波指數 < 10%
- 此型號認證由可實驗室發出之安全認證消防測試, 環保物料 (RoHS), 光生物安全為 Exemption Group 及其它測試, 保證客戶使用更安心滿意

Downlight

天花燈

Downlight

Series Type: DL-T

Features 產品特點 >>

- Material: Aluminum 6063
- Energy saving: more than 70% energy saving than traditional downlight
- Uniform light emission without flicker
- Lightweight and easy to install
- White external frame can be integrated into any environment
- Designed for commercial and residential use in recessed spaces

- 材質: 鋁6063
- 節能: 比傳統筒燈節能70%以上
- 發光均勻, 無頻閃
- 質量輕, 方便安裝
- 白色外部框架可融入任何環境
- 專為商業和住宅嵌入式使用而設計

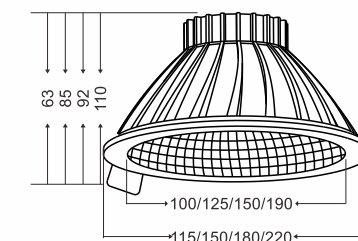

(Unit: mm)

Specification 產品規格 >>

Model 型號	Voltage 電壓	Power 功率	Lumen Output 輸出流明	Color Rendering 顯色度	Colour Temp 色溫	Life Time 壽命	Beam Angle 光束角	Working temperature 工作溫度	Size 尺寸
	(V)	(W)	(Lm/W)	(CRI)	(K)	(H)	(°)	(°C)	(mm)
DL-0405-T108E	85-265	5	100	>80	2700~6500	50000	90	-20~45	Φ115*63
DL-0507-T108E	85-265	7	100	>80	2700~6500	50000	90	-20~45	Φ150*85
DL-0608-T108E	85-265	8	100	>80	2700~6500	50000	90	-20~45	Φ180*92
DL-0810-T108E	85-265	9	100	>80	2700~6500	50000	90	-20~45	Φ220*110

- Light efficiency (lm/W), Power (W), Color Rendering Index (CRI), Size Can be customized according to customer needs
- Our Standard Power factor (PF) > 0.9 and Total harmonic index THD < 15%, According to customer requirements can produce a lower THD < 10%
- This type of certification is issued by a government-approved laboratory for Safety certification, Fire testing, Restriction of Hazardous Substances (RoHS), Photobiological safety of lamps and lamp systems. (an Exemption Group) and other test certifications to ensure product quality

- 光效 (lm/W)、功率 (W)、顯色指數 (CRI)、長度, 可根據客戶需求定制
- 此型號標準之功率因素 (PF) > 0.9, 總諧波指數 THD < 15%, 可按客戶需要生產低總諧波指數 < 10%
- 此型號認證由可實驗室發出之安全認證消防測試, 環保物料 (RoHS), 光生物安全為 Exemption Group 及其它測試, 保證客戶使用更安心滿意

Downlight

Series Type: DL-H

Features 產品特點 >>

- Material: Aluminum 6063
- Energy saving: more than 70% energy saving than traditional downlight
- Uniform light emission without flicker
- Lightweight and easy to install
- White external frame can be integrated into any environment
- Designed for commercial and residential use in recessed spaces

- 材質: 鋁6063
- 節能: 比傳統筒燈節能70%以上
- 發光均勻, 無頻閃
- 質量輕, 方便安裝
- 白色外部框架可融入任何環境
- 專為商業和住宅嵌入式使用而設計

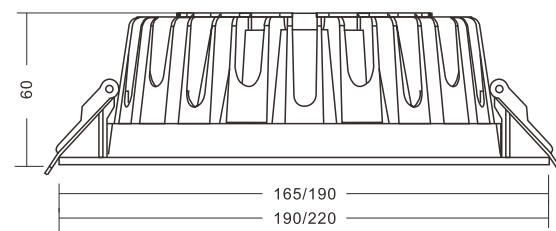

(Unit : mm)

Specification 產品規格 >>

Model 型號	Voltage 電壓	Power 功率	Lumen Output 輸出流明	Color Rendering 顯色度	Colour Temp 色溫	Life Time 壽命	Beam Angle 光束角	Working temperature 工作溫度	Size 尺寸
	(V)	(W)	(Lm/W)	(CRI)	(K)	(H)	(°)	(°C)	(mm)
DL-0620-H108B	85-265	20	100	>80	2700~6500	50000	90	-20~45	Φ190*60
DL-0824-H108B	85-265	24	100	>80	2700~6500	50000	90	-20~45	Φ220*60

- Light efficiency (lm/W), Power (W), Color Rendering Index (CRI), Size Can be customized according to customer needs
- Our Standard Power factor (PF) > 0.9 and Total harmonic index THD < 15%, According to customer requirements can produce a lower THD < 10%
- This type of certification is issued by a government-approved laboratory for Safety certification, Fire testing, Restriction of Hazardous Substances (RoHS), Photobiological safety of lamps and lamp systems. (an Exemption Group) and other test certifications to ensure product quality

- 光效 (lm/W)、功率 (W)、顯色指數 (CRI)、長度, 可根據客戶需求定制
- 此型號標準之功率因素 (PF) > 0.9, 總諧波指數 THD < 15%, 可按客戶需要生產低總諧波指數 < 10%
- 此型號認證由可實驗室發出之安全認證消防測試, 環保物料 (RoHS), 光生物安全為 Exemption Group 及其它測試, 保證客戶使用更安心滿意

Downlight

Series Type: DL-N

Features 產品特點 >>

- Material: Aluminum 6063
- Energy saving: more than 70% energy saving than traditional downlight
- Uniform light emission without flicker
- Lightweight and easy to install
- White external frame can be integrated into any environment
- Designed for commercial and residential use in recessed spaces

- 材質: 鋁6063
- 節能: 比傳統筒燈節能70%以上
- 發光均勻, 無頻閃
- 質量輕, 方便安裝
- 白色外部框架可融入任何環境
- 專為商業和住宅嵌入式使用而設計

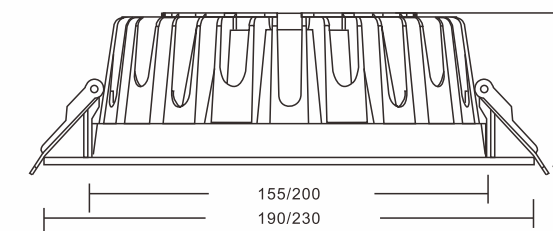

(Unit : mm)

Specification 產品規格 >>

Model 型號	Voltage 電壓	Power 功率	Lumen Output 輸出流明	Color Rendering 顯色度	Colour Temp 色溫	Life Time 壽命	Beam Angle 光束角	Working temperature 工作溫度	Size 尺寸
	(V)	(W)	(Lm/W)	(CRI)	(K)	(H)	(°)	(°C)	(mm)
DL-0612-N118B	85-265	12	110	>80	2700~6500	50000	90	-20~45	Φ190*60
DL-0825-N118B	85-265	25	110	>80	2700~6500	50000	90	-20~45	Φ230*60

- Light efficiency (lm/W), Power (W), Color Rendering Index (CRI), Size Can be customized according to customer needs
- Our Standard Power factor (PF) > 0.9 and Total harmonic index THD < 15%, According to customer requirements can produce a lower THD < 10%
- This type of certification is issued by a government-approved laboratory for Safety certification, Fire testing, Restriction of Hazardous Substances (RoHS), Photobiological safety of lamps and lamp systems. (an Exemption Group) and other test certifications to ensure product quality

- 光效 (lm/W)、功率 (W)、顯色指數 (CRI)、長度, 可根據客戶需求定制
- 此型號標準之功率因素 (PF) > 0.9, 總諧波指數 THD < 15%, 可按客戶需要生產低總諧波指數 < 10%
- 此型號認證由可實驗室發出之安全認證消防測試, 環保物料 (RoHS), 光生物安全為 Exemption Group 及其它測試, 保證客戶使用更安心滿意

Downlight

Series Type: DL-L

Features 產品特點 >>

- Material: Aluminum 6063
- Energy saving: more than 70% energy saving than traditional downlight
- Uniform light emission without flicker
- Lightweight and easy to install
- White external frame can be integrated into any environment
- Designed for commercial and residential use in recessed spaces

- 材質: 鋁6063
- 節能: 比傳統筒燈節能70%以上
- 發光均勻, 無頻閃
- 質量輕, 方便安裝
- 白色外部框架可融入任何環境
- 專為商業和住宅嵌入式使用而設計

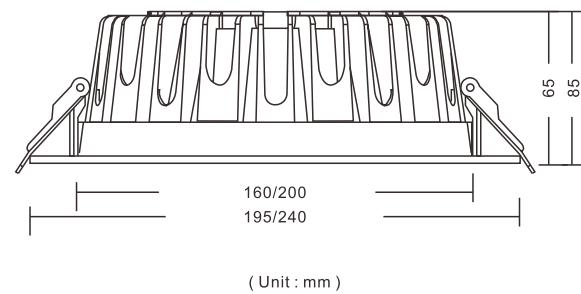

Specification 產品規格 >>

Model 型號	Voltage 電壓	Power 功率	Lumen Output 輸出流明	Color Rendering 顯色度	Colour Temp 色溫	Life Time 壽命	Beam Angle 光束角	Working temperature 工作溫度	Size 尺寸
	(V)	(W)	(Lm/W)	(CRI)	(K)	(H)	(°)	(°C)	(mm)
DL-0615-L108B	85-265	15	100	>80	2700~6500	50000	90	-20~45	Φ195*65
DL-0820-L108B	85-265	20	100	>80	2700~6500	50000	90	-20~45	Φ240*85

- Light efficiency (lm/W), Power (W), Color Rendering Index (CRI), Size Can be customized according to customer needs
- Our Standard Power factor (PF) > 0.9 and Total harmonic index THD < 15%, According to customer requirements can produce a lower THD < 10%
- This type of certification is issued by a government-approved laboratory for Safety certification, Fire testing, Restriction of Hazardous Substances (RoHS), Photobiological safety of lamps and lamp systems. (an Exemption Group) and other test certifications to ensure product quality

- 光效 (lm/W)、功率 (W)、顯色指數 (CRI)、長度, 可根據客戶需求定制
- 此型號標準之功率因素 (PF) > 0.9, 總諧波指數 THD < 15%, 可按客戶需要生產低總諧波指數 < 10%
- 此型號認證由可實驗室發出之安全認證消防測試, 環保物料 (RoHS), 光生物安全為 Exemption Group 及其它測試, 保證客戶使用更安心滿意

Downlight

Series Type: DL-I

Features 產品特點 >>

- Material: Aluminum 6063
- Energy saving: more than 70% energy saving than traditional downlight
- Uniform light emission without flicker
- Lightweight and easy to install
- White external frame can be integrated into any environment
- Designed for commercial and residential use in recessed spaces

- 材質: 鋁6063
- 節能: 比傳統筒燈節能70%以上
- 發光均勻, 無頻閃
- 質量輕, 方便安裝
- 白色外部框架可融入任何環境
- 專為商業和住宅嵌入式使用而設計

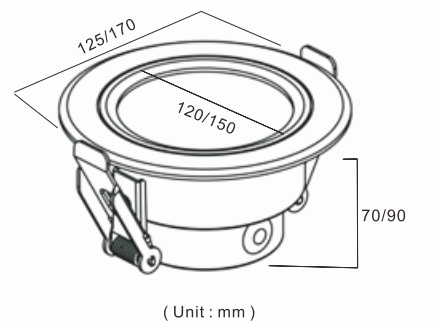

Specification 產品規格 >>

Model 型號	Voltage 電壓	Power 功率	Lumen Output 輸出流明	Color Rendering 顯色度	Colour Temp 色溫	Life Time 壽命	Beam Angle 光束角	Working temperature 工作溫度	Size 尺寸
	(V)	(W)	(Lm/W)	(CRI)	(K)	(H)	(°)	(°C)	(mm)
DL-0506-I118B	85-265	6	110	>80	2700~6500	50000	90	-20~45	Φ125*70
DL-0608-I118B	85-265	8	110	>80	2700~6500	50000	90	-20~45	Φ170*90

- Light efficiency (lm/W), Power (W), Color Rendering Index (CRI), Size Can be customized according to customer needs
- Our Standard Power factor (PF) > 0.9 and Total harmonic index THD < 15%, According to customer requirements can produce a lower THD < 10%
- This type of certification is issued by a government-approved laboratory for Safety certification, Fire testing, Restriction of Hazardous Substances (RoHS), Photobiological safety of lamps and lamp systems. (an Exemption Group) and other test certifications to ensure product quality

- 光效 (lm/W)、功率 (W)、顯色指數 (CRI)、長度, 可根據客戶需求定制
- 此型號標準之功率因素 (PF) > 0.9, 總諧波指數 THD < 15%, 可按客戶需要生產低總諧波指數 < 10%
- 此型號認證由可實驗室發出之安全認證消防測試, 環保物料 (RoHS), 光生物安全為 Exemption Group 及其它測試, 保證客戶使用更安心滿意

Downlight

Series Type: DL-R

Features 產品特點 >>

- Material: Aluminum 6063
- Energy saving: more than 70% energy saving than traditional downlight
- Uniform light emission without flicker
- Lightweight and easy to install
- White external frame can be integrated into any environment
- Designed for commercial and residential use in recessed spaces

- 材質: 鋁6063
- 節能: 比傳統筒燈節能70%以上
- 發光均勻, 無頻閃
- 質量輕, 方便安裝
- 白色外部框架可融入任何環境
- 專為商業和住宅嵌入式使用而設計

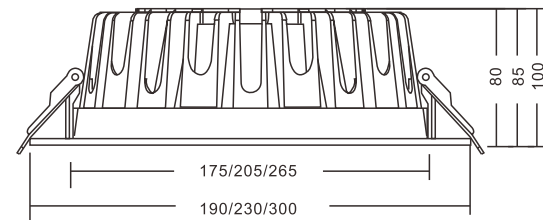

(Unit : mm)

Specification 產品規格 >>

Model 型號	Voltage 電壓	Power 功率	Lumen Output 輸出流明	Color Rendering 顯色度	Colour Temp 色溫	Life Time 壽命	Beam Angle 光束角	Working temperature 工作溫度	Size 尺寸
	(V)	(W)	(Lm/W)	(CRI)	(K)	(H)	(°)	(°C)	(mm)
DL-0612-R108B	85-265	12	100	>80	2700~6500	50000	90	-20~45	Φ190*80
DL-0820-R108B	85-265	20	100	>80	2700~6500	50000	90	-20~45	Φ230*85
DL-1035-R108B	85-265	35	100	>80	2700~6500	50000	90	-20~45	Φ300*100

- Light efficiency (lm/W), Power (W), Color Rendering Index (CRI), Size Can be customized according to customer needs
- Our Standard Power factor (PF) > 0.9 and Total harmonic index THD < 15%, According to customer requirements can produce a lower THD < 10%
- This type of certification is issued by a government-approved laboratory for Safety certification, Fire testing, Restriction of Hazardous Substances (RoHS), Photobiological safety of lamps and lamp systems. (an Exemption Group) and other test certifications to ensure product quality

- 光效 (lm/W)、功率 (W)、顯色指數 (CRI)、長度, 可根據客戶需求定制
- 此型號標準之功率因素 (PF) > 0.9, 總諧波指數 THD < 15%, 可按客戶需要生產低總諧波指數 < 10%
- 此型號認證由可實驗室發出之安全認證消防測試, 環保物料 (RoHS), 光生物安全為 Exemption Group 及其它測試, 保證客戶使用更安心滿意

Downlight

Series Type: DL-UC

Features 產品特點 >>

- Material: Aluminum 6063
- Energy saving: more than 70% energy saving than traditional downlight
- Uniform light emission without flicker
- Low Heat generation
- Lightweight and easy to install
- White external frame can be integrated into any environment
- Designed for commercial and residential use in recessed spaces

- 材質: 鋁6063
- 節能: 比傳統筒燈節能70%以上
- 發光均勻, 無頻閃
- 低熱能釋放
- 質量輕, 方便安裝
- 白色外部框架可融入任何環境
- 專為商業和住宅嵌入式使用而設計

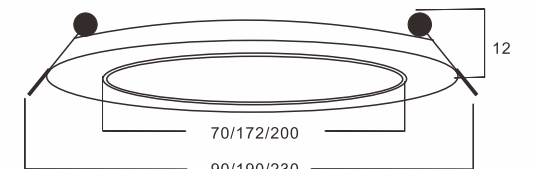

(Unit : mm)

Specification 產品規格 >>

Model 型號	Voltage 電壓	Power 功率	Lumen Output 輸出流明	Color Rendering 顯色度	Colour Temp 色溫	Life Time 壽命	Beam Angle 光束角	Working temperature 工作溫度	Size 尺寸
	(V)	(W)	(Lm/W)	(CRI)	(K)	(H)	(°)	(°C)	(mm)
DL-0303-UC108A	85-265	3	100	>80	2700~6500	50000	180	-20~45	Φ90*12
DL-0612-UC108A	85-265	12	100	>80	2700~6500	50000	180	-20~45	Φ190*12
DL-0818-UC108A	85-265	18	100	>80	2700~6500	50000	180	-20~45	Φ230*12

- Light efficiency (lm/W), Power (W), Color Rendering Index (CRI), Size Can be customized according to customer needs
- Our Standard Power factor (PF) > 0.9 and Total harmonic index THD < 15%, According to customer requirements can produce a lower THD < 10%
- This type of certification is issued by a government-approved laboratory for Safety certification, Fire testing, Restriction of Hazardous Substances (RoHS), Photobiological safety of lamps and lamp systems. (an Exemption Group) and other test certifications to ensure product quality

- 光效 (lm/W)、功率 (W)、顯色指數 (CRI)、長度, 可根據客戶需求定制
- 此型號標準之功率因素 (PF) > 0.9, 總諧波指數 THD < 15%, 可按客戶需要生產低總諧波指數 < 10%
- 此型號認證由可實驗室發出之安全認證消防測試, 環保物料 (RoHS), 光生物安全為 Exemption Group 及其它測試, 保證客戶使用更安心滿意

Downlight

Series Type: DL-S

Features 產品特點 >>

- Material: Aluminum 6063+PC
- Energy saving: more than 70% energy saving than traditional downlight
- Uniform light emission without flicker
- Low Heat generation
- Lightweight and easy to install
- White external frame can be integrated into any environment
- Designed for commercial and residential use in recessed spaces

- 材質: 鋁6063+PC
- 節能: 比傳統筒燈節能70%以上
- 發光均勻, 無頻閃
- 低熱能釋放
- 質量輕, 方便安裝
- 白色外部框架可融入任何環境
- 專為商業和住宅嵌入式使用而設計



Flick Free
(無閃頻)
保護視力

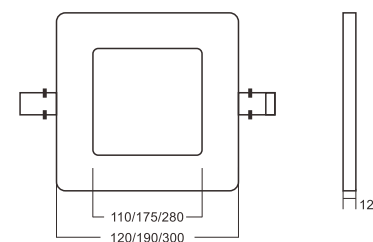

(Unit : mm)

Specification 產品規格 >>

Model 型號	Voltage 電壓	Power 功率	Lumen Output 輸出流明	Color Rendering 顯色度	Colour Temp 色溫	Life Time 壽命	Beam Angle 光束角	Working temperature 工作溫度	Size 尺寸
	(V)	(W)	(Lm/W)	(CRI)	(K)	(H)	(°)	(°C)	(mm)
DL-0406-MEP-S	85-265	6	100	>80	2700~6500	50000	180	-20~45	120*12
DL-0715-MEP-S	85-265	15	100	>80	2700~6500	50000	180	-20~45	190*12
DL-1024-MEP-S	85-265	24	100	>80	2700~6500	50000	180	-20~45	300*12

- Light efficiency (lm/W), Power (W), Color Rendering Index (CRI), Size Can be customized according to customer needs
- Our Standard Power factor (PF) > 0.9 and Total harmonic index THD < 15%, According to customer requirements can produce a lower THD < 10%
- This type of certification is issued by a government-approved laboratory for Safety certification, Fire testing, Restriction of Hazardous Substances (RoHS), Photobiological safety of lamps and lamp systems. (an Exemption Group) and other test certifications to ensure product quality

- 光效 (lm/W)、功率 (W)、顯色指數 (CRI)、長度, 可根據客戶需求定制
- 此型號標準之功率因素 (PF) > 0.9, 總諧波指數 THD < 15%, 可按客戶需要生產低總諧波指數 < 10%
- 此型號認證由可實驗室發出之安全認證消防測試, 環保物料 (RoHS), 光生物安全為 Exemption Group 及其它測試, 保證客戶使用更安心滿意

Downlight

Series Type: DL-UC

Features 產品特點 >>

- The lamp body is made of thick aluminum, which is strong, wear-resistant and not easy to deform
- Built-in thick aluminum radiator, strong convection design, strong heat dissipation effect
- Aluminum reflective mask, uniform light output and good light effect
- Long irradiation range, long service life, no video flicker, strong color rendering
- Double head adjustable Angle, vertical adjustable 90 degrees, horizontal rotation 350 degrees

- 燈體由厚鋁製成, 堅固耐磨, 不易變形
- 內真厚鋁散熱器, 強對流設計, 散熱效果強
- 鋁制反光罩, 光輸出均勻, 光效好
- 照射範圍長, 使用壽命長, 無視頻閃爍, 顯色性強
- 雙頭可調角度, 垂直可調90度, 水準旋轉350度



Flick Free
(無閃頻)
保護視力

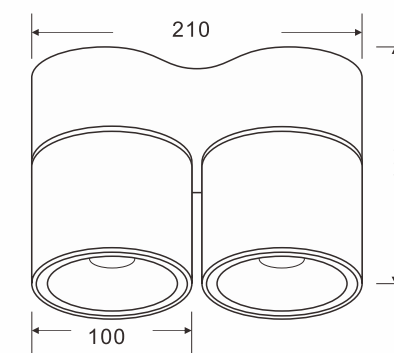

(Unit : mm)

Specification 產品規格 >>

Model 型號	Voltage 電壓	Power 功率	Lumen Output 輸出流明	Color Rendering 顯色度	Colour Temp 色溫	Life Time 壽命	Beam Angle 光束角	Working temperature 工作溫度	Size 尺寸
	(V)	(W)	(Lm/W)	(CRI)	(K)	(H)	(°)	(°C)	(mm)
DL-OA-2*10W	220-240	2*10	110	>80	3000/4000/6000	50000	180	-20~45	Φ100*210*110

- Light efficiency (lm/W), Power (W), Color Rendering Index (CRI), Size Can be customized according to customer needs
- Our Standard Power factor (PF) > 0.9 and Total harmonic index THD < 15%, According to customer requirements can produce a lower THD < 10%
- This type of certification is issued by a government-approved laboratory for Safety certification, Fire testing, Restriction of Hazardous Substances (RoHS), Photobiological safety of lamps and lamp systems. (an Exemption Group) and other test certifications to ensure product quality

- 光效 (lm/W)、功率 (W)、顯色指數 (CRI)、長度, 可根據客戶需求定制
- 此型號標準之功率因素 (PF) > 0.9, 總諧波指數 THD < 15%, 可按客戶需要生產低總諧波指數 < 10%
- 此型號認證由可實驗室發出之安全認證消防測試, 環保物料 (RoHS), 光生物安全為 Exemption Group 及其它測試, 保證客戶使用更安心滿意

Recessed LED Down Light

Series Type: DL-0620

Features 產品特點 >>

- Material: Aluminum 6063+PC
- Mat white outer frame blend into any interior
- Compatible in use with most emergency battery
- Designed for commercial and residential use in recessed spaces

- 材質: 鋁6063+PC
- 白色外框融入任何內部
- 與大多數應急電池相容使用
- 專為商業和住宅嵌入式使用而設計



Flick Free
(無閃頻)
保護視力

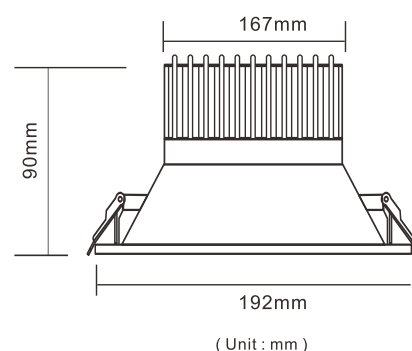

Specification 產品規格 >>

Model 型號	Voltage 電壓	Power 功率	Lumen Output 輸出流明	Color Rendering 顯色度	Colour Temp 色溫	Life Time 壽命	Viewing Angle 光束角	Working temperature 工作溫度	Size 尺寸
	(V)	(W)	(Lm/W)	(CRI)	(K)	(H)	(°)	(°C)	(mm)
DL-0620	100-240	10	90	>80	4000	50000	141	-20~45	Φ192*H90

- Light efficiency (lm/W), Power (W), Color Rendering Index (CRI), Size Can be customized according to customer needs
- Our Standard Power factor (PF) > 0.9 and Total harmonic index THD < 15%, According to customer requirements can produce a lower THD < 10%
- This type of certification is issued by a government-approved laboratory for Safety certification, Fire testing, Restriction of Hazardous Substances (RoHS), Photobiological safety of lamps and lamp systems. (an Exemption Group) and other test certifications to ensure product quality

- 光效 (lm/W)、功率 (W)、顯色指數 (CRI)、長度, 可根據客戶需求定制
- 此型號標準之功率因素 (PF) > 0.9, 總諧波指數 THD < 15%, 可按客戶需要生產低總諧波指數 < 10%
- 此型號認證由可實驗室發出之安全認證消防測試, 環保物料 (RoHS), 光生物安全為 Exemption Group 及其它測試, 保證客戶使用更安心滿意

LED Down Light

Series Type: DL-0412

Features 產品特點 >>

- Material: Aluminum 6063+PC
- Designed for commercial usage
- High light efficacy
- Low heat generation
- Uniform light emission
- Remote 0-10V dimmable LED driver

- 材質: 鋁6063+PC
- 專為商業用途而設計
- 高光效
- 低熱產生
- 均勻發光
- 遠程0-10V可調光LED驅動器



Flick Free
(無閃頻)
保護視力



Specification 產品規格 >>

Model 型號	Voltage 電壓	Power 功率	Lumen Output 輸出流明	Color Rendering 顯色度	Colour Temp 色溫	Life Time 壽命	Beam Angle 光束角	Working temperature 工作溫度	Size 尺寸
	(V)	(W)	(Lm/W)	(CRI)	(K)	(H)	(°)	(°C)	(mm)
DL-0412	110-240	11	100	>80	3000/4000/6000	50000	24	-20~45	Φ84*H76

- Light efficiency (lm/W), Power (W), Color Rendering Index (CRI), Size Can be customized according to customer needs
- Our Standard Power factor (PF) > 0.9 and Total harmonic index THD < 15%, According to customer requirements can produce a lower THD < 10%
- This type of certification is issued by a government-approved laboratory for Safety certification, Fire testing, Restriction of Hazardous Substances (RoHS), Photobiological safety of lamps and lamp systems. (an Exemption Group) and other test certifications to ensure product quality

- 光效 (lm/W)、功率 (W)、顯色指數 (CRI)、長度, 可根據客戶需求定制
- 此型號標準之功率因素 (PF) > 0.9, 總諧波指數 THD < 15%, 可按客戶需要生產低總諧波指數 < 10%
- 此型號認證由可實驗室發出之安全認證消防測試, 環保物料 (RoHS), 光生物安全為 Exemption Group 及其它測試, 保證客戶使用更安心滿意

Recessed LED Down Light

Series Type: DL-0408

Features 產品特點 >>

- Material: Aluminum 6063+PC
- Mat white outer frame blend into any interior
- High Light Efficacy : 80lm / W
- Low heat generation
- Uniform light emission
- Designed for commercial and residential use in recessed spaces

- 材質: 鋁6063+PC
- 白色外框融入任何內部
- 高光效: 80lm/W
- 低熱產生
- 均勻發光
- 專為商業和住宅嵌入式使用而設計



Flick Free
(無閃頻)
保護視力

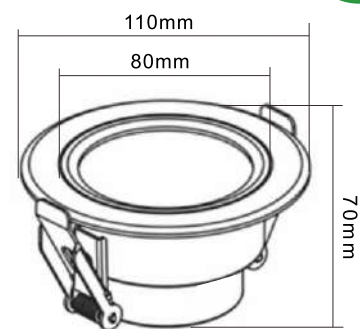

(Unit : mm)

Specification 產品規格 >>

Model 型號	Voltage 電壓	Power 功率	Lumen Output 輸出流明	Color Rendering 顯色度	Colour Temp 色溫	Life Time 壽命	Viewing Angle 光束角	Working temperature 工作溫度	Size 尺寸
	(V)	(W)	(Lm/W)	(CRI)	(K)	(H)	(°)	(°C)	(mm)
DL-0408	85-265	3.5	80	>80	2700	50000	120	-20~45	Φ110*H70

- Light efficiency (lm/W), Power (W), Color Rendering Index (CRI), Size Can be customized according to customer needs
- Our Standard Power factor (PF) > 0.9 and Total harmonic index THD < 15%. According to customer requirements can produce a lower THD < 10%
- This type of certification is issued by a government-approved laboratory for Safety certification, Fire testing, Restriction of Hazardous Substances (RoHS), Photobiological safety of lamps and lamp systems. (an Exemption Group) and other test certifications to ensure product quality

- 光效 (lm/W)、功率 (W)、顯色指數 (CRI)、長度, 可根據客戶需求定制
- 此型號標準之功率因素 (PF) > 0.9, 總諧波指數 THD < 15%, 可按客戶需要生產低總諧波指數 < 10%
- 此型號認證由可實驗室發出之安全認證消防測試, 環保物料 (RoHS), 光生物安全為 Exemption Group 及其它測試, 保證客戶使用更安心滿意



Track Light

軌道燈



Track Light

Series Type: TL-Q

Features 產品特點 >>

- Material: high quality aluminum alloy profile + PC reflector with lens
- Dark light Aluminum reflector UGR<19
- Uniform light emission without flicker
- The position can be adjusted in multiple directions as required
- Application: shopping malls, jewelry, brand clothing, high-end clubs, professional windows, counters and other key lighting places
- Certificate: CE RoHS

- 材质: 优质铝合金型材+带透镜的PC反光镜
- 暗光铝反射镜UGR <19
- 发光均匀, 无频闪
- 照射位置可根据需要进行多个方位调整
- 应用场所: 商场、珠宝首饰、品牌服饰、高档会所、专业橱窗、柜台等重点照明场所
- 证书: CE RoHS



Flick Free
(無閃頻)
保護視力

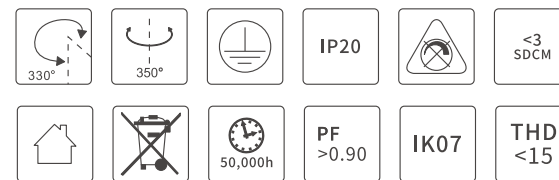

Specification 產品規格 >>

Model 型號	Voltage 電壓 (V)	Power 功率 (W)	Lumen Output 輸出流明 (Lm/W)	Color Rendering 顯色度 (CRI)	Colour Temp 色溫 (K)	Life Time 壽命 (H)	Beam Angle 光束角 (°)	Working temperature 工作溫度 (°C)	Size 尺寸 (mm)
TL-A20-H108E-Q	100~240	20	100	>80	2700/3000/4000/5000	50000	15/24/38/60	-20~45	Φ90*155
TL-A25-H108E-Q	100~240	25	100	>80	2700/3000/4000/5000	50000	15/24/38/60	-20~45	Φ90*155
TL-A30-H108E-Q	100~240	30	100	>80	2700/3000/4000/5000	50000	15/24/38/60	-20~45	Φ90*155

- Light efficiency (lm/W), Power (W), Color Rendering Index (CRI), Size Can be customized according to customer needs
- Our Standard Power factor (PF) > 0.9 and Total harmonic index THD < 15%, According to customer requirements can produce a lower THD < 10%
- This type of certification is issued by a government-approved laboratory for Safety certification, Fire testing, Restriction of Hazardous Substances (RoHS), Photobiological safety of lamps and lamp systems, (an Exemption Group) and other test certifications to ensure product quality

- 光效 (lm/W)、功率 (W)、顯色指數 (CRI)、長度, 可根據客戶需求定制
- 此型號標準之功率因素 (PF) > 0.9, 總諧波指數 THD < 15%, 可按客戶需要生產低總諧波指數 < 10%
- 此型號認證由可實驗室發出之安全認證消防測試, 環保物料 (RoHS), 光生物安全為 Exemption Group 及其它測試, 保證客戶使用更安心滿意

Track Light

Series Type: TL-P

Features 產品特點 >>

- Material: high quality aluminum alloy profile + PC reflector with lens
- Dark light Aluminum reflector UGR<19
- Uniform light emission without flicker
- The position can be adjusted in multiple directions as required
- Application: shopping malls, jewelry, brand clothing, high-end clubs, professional windows, counters and other key lighting places
- Certificate: CE RoHS

- 材质: 优质铝合金型材+带透镜的PC反光镜
- 暗光铝反射镜UGR <19
- 发光均匀, 无频闪
- 照射位置可根据需要进行多个方位调整
- 应用场所: 商场、珠宝首饰、品牌服饰、高档会所、专业橱窗、柜台等重点照明场所
- 证书: CE RoHS



Flick Free
(無閃頻)
保護視力

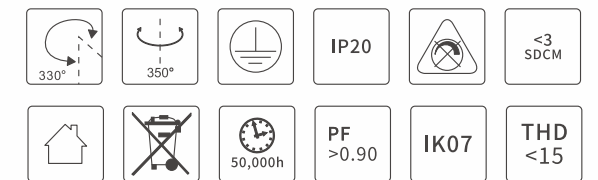

Specification 產品規格 >>

Model 型號	Voltage 電壓 (V)	Power 功率 (W)	Lumen Output 輸出流明 (Lm/W)	Color Rendering 顯色度 (CRI)	Colour Temp 色溫 (K)	Life Time 壽命 (H)	Beam Angle 光束角 (°)	Working temperature 工作溫度 (°C)	Size 尺寸 (mm)
TL-A15-H108E-P	100~240	15	100	>80	2700/3000/4000/5000	50000	15/24/38/60	-20~45	Φ90*155
TL-A20-H108E-P	100~240	20	100	>80	2700/3000/4000/5000	50000	15/24/38/60	-20~45	Φ90*155
TL-A30-H108E-P	100~240	30	100	>80	2700/3000/4000/5000	50000	15/24/38/60	-20~45	Φ90*155

- Light efficiency (lm/W), Power (W), Color Rendering Index (CRI), Size Can be customized according to customer needs
- Our Standard Power factor (PF) > 0.9 and Total harmonic index THD < 15%, According to customer requirements can produce a lower THD < 10%
- This type of certification is issued by a government-approved laboratory for Safety certification, Fire testing, Restriction of Hazardous Substances (RoHS), Photobiological safety of lamps and lamp systems, (an Exemption Group) and other test certifications to ensure product quality

- 光效 (lm/W)、功率 (W)、顯色指數 (CRI)、長度, 可根據客戶需求定制
- 此型號標準之功率因素 (PF) > 0.9, 總諧波指數 THD < 15%, 可按客戶需要生產低總諧波指數 < 10%
- 此型號認證由可實驗室發出之安全認證消防測試, 環保物料 (RoHS), 光生物安全為 Exemption Group 及其它測試, 保證客戶使用更安心滿意

Track Light

Series Type: TL-OR

Features 產品特點 >>

- Material: high quality aluminum alloy profile + PC reflector with lens
- Dark light Aluminum reflector UGR<19
- Uniform light emission without flicker
- The position can be adjusted in multiple directions as required
- Application: shopping malls, jewelry, brand clothing, high-end clubs, professional windows, counters and other key lighting places
- Certificate: CE RoHS

- 材质: 优质铝合金型材+带透镜的PC反光镜
- 暗光铝反射镜UGR <19
- 发光均匀, 无频闪
- 照射位置可根据需要进行多个方位调整
- 应用场所: 商场、珠宝首饰、品牌服饰、高档会所、专业橱窗、柜台等重点照明场所
- 证书: CE RoHS

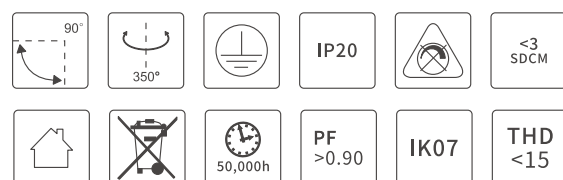

Specification 產品規格 >>

Model 型號	Voltage 電壓 (V)	Power 功率 (W)	Lumen Output 輸出流明 (Lm/W)	Color Rendering 顯色度 (CRI)	Colour Temp 色溫 (K)	Life Time 壽命 (H)	Beam Angle 光束角 (°)	Working temperature 工作溫度 (°C)	Size 尺寸 (mm)
TL-A15-H108E-OR	100~240	15	100	>80	2700/3000/4000/5000	50000	15/24/38/60	-20~45	Φ90*108
TL-A20-H108E-OR	100~240	20	100	>80	2700/3000/4000/5000	50000	15/24/38/60	-20~45	Φ90*108
TL-A30-H108E-OR	100~240	30	100	>80	2700/3000/4000/5000	50000	15/24/38/60	-20~45	Φ90*108

- Light efficiency (lm/W), Power (W), Color Rendering Index (CRI), Size Can be customized according to customer needs
- Our Standard Power factor (PF) > 0.9 and Total harmonic index THD < 15%, According to customer requirements can produce a lower THD < 10%
- This type of certification is issued by a government-approved laboratory for Safety certification, Fire testing, Restriction of Hazardous Substances (RoHS), Photobiological safety of lamps and lamp systems, (an Exemption Group) and other test certifications to ensure product quality

- 光效 (lm/W)、功率 (W)、顯色指數 (CRI)、長度, 可根據客戶需求定制
- 此型號標準之功率因素 (PF) > 0.9, 總諧波指數 THD < 15%, 可按客戶需要生產低總諧波指數 < 10%
- 此型號認證由可實驗室發出之安全認證消防測試, 環保物料 (RoHS), 光生物安全為 Exemption Group 及其它測試, 保證客戶使用更安心滿意

Track Light

Series Type: TL-F1

Features 產品特點 >>

- Material: high quality aluminum alloy profile + PC reflector with lens
- Dark light Aluminum reflector UGR<19
- Uniform light emission without flicker
- The position can be adjusted in multiple directions as required
- Application: shopping malls, jewelry, brand clothing, high-end clubs, professional windows, counters and other key lighting places
- Certificate: CE RoHS

- 材质: 优质铝合金型材+带透镜的PC反光镜
- 暗光铝反射镜UGR <19
- 发光均匀, 无频闪
- 照射位置可根据需要进行多个方位调整
- 应用场所: 商场、珠宝首饰、品牌服饰、高档会所、专业橱窗、柜台等重点照明场所
- 证书: CE RoHS

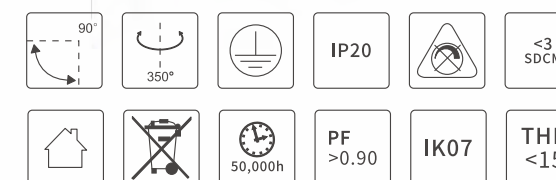

Specification 產品規格 >>

Model 型號	Voltage 電壓 (V)	Power 功率 (W)	Lumen Output 輸出流明 (Lm/W)	Color Rendering 顯色度 (CRI)	Colour Temp 色溫 (K)	Life Time 壽命 (H)	Beam Angle 光束角 (°)	Working temperature 工作溫度 (°C)	Size 尺寸 (mm)
TL-A15-H108E-F1	100~240	15	100	>80	2700/3000/4000/5000	50000	15/24/38/60	-20~45	Φ62*140
TL-A20-H108E-F1	100~240	20	100	>80	2700/3000/4000/5000	50000	15/24/38/60	-20~45	Φ90*165
TL-A30-H108E-F1	100~240	30	100	>80	2700/3000/4000/5000	50000	15/24/38/60	-20~45	Φ90*165

- Light efficiency (lm/W), Power (W), Color Rendering Index (CRI), Size Can be customized according to customer needs
- Our Standard Power factor (PF) > 0.9 and Total harmonic index THD < 15%, According to customer requirements can produce a lower THD < 10%
- This type of certification is issued by a government-approved laboratory for Safety certification, Fire testing, Restriction of Hazardous Substances (RoHS), Photobiological safety of lamps and lamp systems, (an Exemption Group) and other test certifications to ensure product quality

- 光效 (lm/W)、功率 (W)、顯色指數 (CRI)、長度, 可根據客戶需求定制
- 此型號標準之功率因素 (PF) > 0.9, 總諧波指數 THD < 15%, 可按客戶需要生產低總諧波指數 < 10%
- 此型號認證由可實驗室發出之安全認證消防測試, 環保物料 (RoHS), 光生物安全為 Exemption Group 及其它測試, 保證客戶使用更安心滿意

Track Light

Series Type: TL-K

Features 產品特點 >>

- Material: high quality aluminum alloy profile + PC reflector with lens
- Dark light Aluminum reflector UGR<19
- Uniform light emission without flicker
- The position can be adjusted in multiple directions as required
- Application: shopping malls, jewelry, brand clothing, high-end clubs, professional windows, counters and other key lighting places
- Certificate: CE RoHS

- 材质: 优质铝合金型材+带透镜的PC反光镜
- 暗光铝反射镜UGR <19
- 发光均匀, 无频闪
- 照射位置可根据需要进行多个方位调整
- 应用场所: 商场、珠宝首饰、品牌服饰、高档会所、专业橱窗、柜台等重点照明场所
- 证书: CE RoHS



Flick Free
(無閃頻)
保護視力

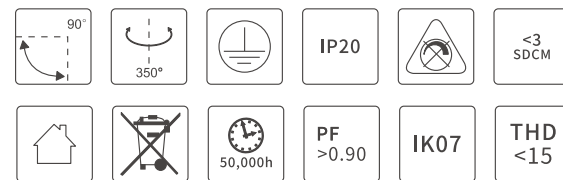

Specification 產品規格 >>

Model 型號	Voltage 電壓 (V)	Power 功率 (W)	Lumen Output 輸出流明 (Lm/W)	Color Rendering 顯色度 (CRI)	Colour Temp 色溫 (K)	Life Time 壽命 (H)	Beam Angle 光束角 (°)	Working temperature 工作溫度 (°C)	Size 尺寸 (mm)
TL-A15-H108E-K	100~240	15	100	>80	2700/3000/4000/5000	50000	15/24/38/60	-20~45	Φ62*140
TL-A20-H108E-K	100~240	20	100	>80	2700/3000/4000/5000	50000	15/24/38/60	-20~45	Φ90*165
TL-A30-H108E-K	100~240	30	100	>80	2700/3000/4000/5000	50000	15/24/38/60	-20~45	Φ90*165

- Light efficiency (lm/W), Power (W), Color Rendering Index (CRI), Size Can be customized according to customer needs
- Our Standard Power factor (PF) > 0.9 and Total harmonic index THD < 15%, According to customer requirements can produce a lower THD < 10%
- This type of certification is issued by a government-approved laboratory for Safety certification, Fire testing, Restriction of Hazardous Substances (RoHS), Photobiological safety of lamps and lamp systems, (an Exemption Group) and other test certifications to ensure product quality

- 光效 (lm/W)、功率 (W)、顯色指數 (CRI)、長度, 可根據客戶需求定制
- 此型號標準之功率因素 (PF) > 0.9, 總諧波指數 THD < 15%, 可按客戶需要生產低總諧波指數 < 10%
- 此型號認證由可實驗室發出之安全認證消防測試, 環保物料 (RoHS), 光生物安全為 Exemption Group 及其它測試, 保證客戶使用更安心滿意

Track Light

Series Type: TL-F1A

Features 產品特點 >>

- Material: high quality aluminum alloy profile + PC reflector with lens
- Dark light Aluminum reflector UGR<19
- Uniform light emission without flicker
- The position can be adjusted in multiple directions as required
- Application: shopping malls, jewelry, brand clothing, high-end clubs, professional windows, counters and other key lighting places
- Certificate: CE RoHS

- 材质: 优质铝合金型材+带透镜的PC反光镜
- 暗光铝反射镜UGR <19
- 发光均匀, 无频闪
- 照射位置可根据需要进行多个方位调整
- 应用场所: 商场、珠宝首饰、品牌服饰、高档会所、专业橱窗、柜台等重点照明场所
- 证书: CE RoHS



Flick Free
(無閃頻)
保護視力

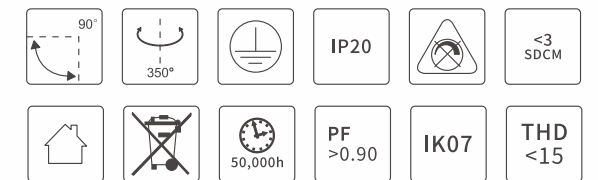

Specification 產品規格 >>

Model 型號	Voltage 電壓 (V)	Power 功率 (W)	Lumen Output 輸出流明 (Lm/W)	Color Rendering 顯色度 (CRI)	Colour Temp 色溫 (K)	Life Time 壽命 (H)	Beam Angle 光束角 (°)	Working temperature 工作溫度 (°C)	Size 尺寸 (mm)
TL-A15-H108E-F1A	100~240	15	100	>80	2700/3000/4000/5000	50000	15/24/38/60	-20~45	Φ62*180
TL-A20-H108E-F1A	100~240	20	100	>80	2700/3000/4000/5000	50000	15/24/38/60	-20~45	Φ90*180
TL-A30-H108E-F1A	100~240	30	100	>80	2700/3000/4000/5000	50000	15/24/38/60	-20~45	Φ90*180

- Light efficiency (lm/W), Power (W), Color Rendering Index (CRI), Size Can be customized according to customer needs
- Our Standard Power factor (PF) > 0.9 and Total harmonic index THD < 15%, According to customer requirements can produce a lower THD < 10%
- This type of certification is issued by a government-approved laboratory for Safety certification, Fire testing, Restriction of Hazardous Substances (RoHS), Photobiological safety of lamps and lamp systems, (an Exemption Group) and other test certifications to ensure product quality

- 光效 (lm/W)、功率 (W)、顯色指數 (CRI)、長度, 可根據客戶需求定制
- 此型號標準之功率因素 (PF) > 0.9, 總諧波指數 THD < 15%, 可按客戶需要生產低總諧波指數 < 10%
- 此型號認證由可實驗室發出之安全認證消防測試, 環保物料 (RoHS), 光生物安全為 Exemption Group 及其它測試, 保證客戶使用更安心滿意

Track Light

Series Type: TL-F2

Features 產品特點 >>

- Material: high quality aluminum alloy profile + PC Lens
 - Uniform light emission without flick
 - High luminous efficiency, energy saving and environmental protection
 - The position can be adjusted in multiple directions as required
 - Application: shopping malls, jewelry, brand clothing, high-end clubs, professional windows, counters and other key lighting places
 - Certificate: CE RoHS
- 材质: 优质铝合金型材+PC透镜
 - 發光均勻, 無頻閃
 - 發光效率高, 節能環保
 - 照射位置可根據需要進行多個方位調整
 - 應用場所: 商場、珠寶首飾、品牌服飾、高檔會所、專業櫥窗、櫃檯等重點照明場所
 - 證書: CE RoHS



Flick Free
(無閃頻)
保護視力

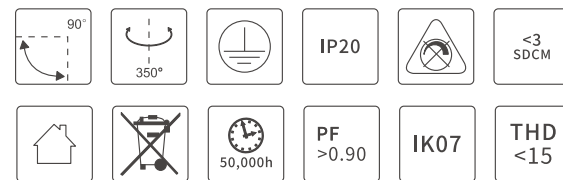

Specification 產品規格 >>

Model 型號	Voltage 電壓 (V)	Power 功率 (W)	Lumen Output 輸出流明 (Lm/W)	Color Rendering 顯色度 (CRI)	Colour Temp 色溫 (K)	Life Time 壽命 (H)	Beam Angle 光束角 (°)	Working temperature 工作溫度 (°C)	Size 尺寸 (mm)
TL-A15-H108E-F2	100~240	15	100	>80	2700/3000/4000/5000	50000	15/24/38	-20~45	Φ80*150
TL-A20-H108E-F2	100~240	20	100	>80	2700/3000/4000/5000	50000	15/24/38	-20~45	Φ80*150
TL-A30-H108E-F2	100~240	30	100	>80	2700/3000/4000/5000	50000	15/24/38	-20~45	Φ90*190

- Light efficiency (lm/W), Power (W), Color Rendering Index (CRI), Size Can be customized according to customer needs
 - Our Standard Power factor (PF) > 0.9 and Total harmonic index THD < 15%, According to customer requirements can produce a lower THD < 10%
 - This type of certification is issued by a government-approved laboratory for Safety certification, Fire testing, Restriction of Hazardous Substances (RoHS), Photobiological safety of lamps and lamp systems. (an Exemption Group) and other test certifications to ensure product quality
- 光效 (lm/W)、功率 (W)、顯色指數 (CRI)、長度, 可根據客戶需求定制
 - 此型號標準之功率因素 (PF) > 0.9, 總諧波指數 THD < 15%, 可按客戶需要生產低總諧波指數 < 10%
 - 此型號認證由可實驗室發出之安全認證消防測試, 環保物料 (RoHS), 光生物安全為 Exemption Group 及其它測試, 保證客戶使用更安心滿意

Track Light

Series Type: TL-O

Features 產品特點 >>

- Material: high quality aluminum alloy profile + PC Lens
 - Uniform light emission without flick
 - High luminous efficiency, energy saving and environmental protection
 - The position can be adjusted in multiple directions as required
 - Application: shopping malls, jewelry, brand clothing, high-end clubs, professional windows, counters and other key lighting places
 - Certificate: CE RoHS
- 材质: 优质铝合金型材+PC透镜
 - 發光均勻, 無頻閃
 - 發光效率高, 節能環保
 - 照射位置可根據需要進行多個方位調整
 - 應用場所: 商場、珠寶首飾、品牌服飾、高檔會所、專業櫥窗、櫃檯等重點照明場所
 - 證書: CE RoHS



Flick Free
(無閃頻)
保護視力

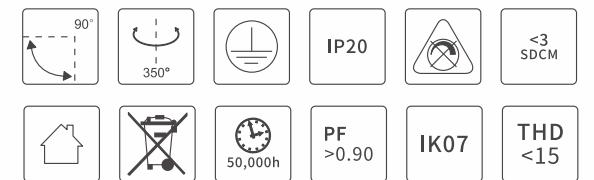

Specification 產品規格 >>

Model 型號	Voltage 電壓 (V)	Power 功率 (W)	Lumen Output 輸出流明 (Lm/W)	Color Rendering 顯色度 (CRI)	Colour Temp 色溫 (K)	Life Time 壽命 (H)	Beam Angle 光束角 (°)	Working temperature 工作溫度 (°C)	Size 尺寸 (mm)
TL-A15-H108E-O	100~240	15	100	>80	2700/3000/4000/5000	50000	15/24/38	-20~45	Φ90*80
TL-A20-H108E-O	100~240	20	100	>80	2700/3000/4000/5000	50000	15/24/38	-20~45	Φ90*80
TL-A30-H108E-O	100~240	30	100	>80	2700/3000/4000/5000	50000	15/24/38	-20~45	Φ110*90

- Light efficiency (lm/W), Power (W), Color Rendering Index (CRI), Size Can be customized according to customer needs
 - Our Standard Power factor (PF) > 0.9 and Total harmonic index THD < 15%, According to customer requirements can produce a lower THD < 10%
 - This type of certification is issued by a government-approved laboratory for Safety certification, Fire testing, Restriction of Hazardous Substances (RoHS), Photobiological safety of lamps and lamp systems. (an Exemption Group) and other test certifications to ensure product quality
- 光效 (lm/W)、功率 (W)、顯色指數 (CRI)、長度, 可根據客戶需求定制
 - 此型號標準之功率因素 (PF) > 0.9, 總諧波指數 THD < 15%, 可按客戶需要生產低總諧波指數 < 10%
 - 此型號認證由可實驗室發出之安全認證消防測試, 環保物料 (RoHS), 光生物安全為 Exemption Group 及其它測試, 保證客戶使用更安心滿意

Track Light

Series Type: TL-M

Features 產品特點 >>

- Material: high quality aluminum alloy profile + PC reflector
- Aluminum reflector UGR<19
- Uniform light emission without flick
- High luminous efficiency, energy saving and environmental protection
- The position can be adjusted in multiple directions as required
- Application: shopping malls, jewelry, brand clothing, high-end clubs, professional windows, counters and other key lighting places
- Certificate: CE RoHS

- 材质: 优质铝合金型材+PC反光鏡
- 鋁反射鏡UGR<19
- 發光均勻, 無頻閃
- 發光效率高, 節能環保
- 照射位置可根據需要進行多個方位調整
- 應用場所: 商場、珠寶首飾、品牌服飾、高檔會所、專業櫥窗、櫃檯等重點照明場所
- 證書: CE RoHS



Flick Free
(無閃頻)
保護視力

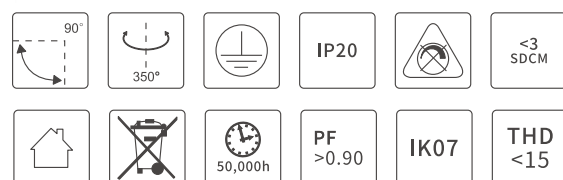

Specification 產品規格 >>

Model 型號	Voltage 電壓 (V)	Power 功率 (W)	Lumen Output 輸出流明 (Lm/W)	Color Rendering 顯色度 (CRI)	Colour Temp 色溫 (K)	Life Time 壽命 (H)	Beam Angle 光束角 (°)	Working temperature 工作溫度 (°C)	Size 尺寸 (mm)
TL-A15-H108E-M	100~240	15	100	>80	2700/3000/4000/5000	50000	15/24/38/60	-20~45	Φ65*165
TL-A20-H108E-M	100~240	20	100	>80	2700/3000/4000/5000	50000	15/24/38/60	-20~45	Φ65*165
TL-A30-H108E-M	100~240	30	100	>80	2700/3000/4000/5000	50000	15/24/38/60	-20~45	Φ85*195

- Light efficiency (lm/W), Power (W), Color Rendering Index (CRI), Size Can be customized according to customer needs
- Our Standard Power factor (PF) > 0.9 and Total harmonic index THD < 15%, According to customer requirements can produce a lower THD < 10%
- This type of certification is issued by a government-approved laboratory for Safety certification, Fire testing, Restriction of Hazardous Substances (RoHS), Photobiological safety of lamps and lamp systems. (an Exemption Group) and other test certifications to ensure product quality
- 光效 (lm/W)、功率 (W)、顯色指數 (CRI)、長度, 可根據客戶需求定制
- 此型號標準之功率因素 (PF) > 0.9, 總諧波指數 THD < 15%, 可按客戶需要生產低總諧波指數 < 10%
- 此型號認證由可實驗室發出之安全認證消防測試, 環保物料 (RoHS), 光生物安全為 Exemption Group 及其它測試, 保證客戶使用更安心滿意

Track Light

Series Type: TL-F1R

Features 產品特點 >>

- Material: high quality aluminum alloy profile + PC Lens
- Uniform light emission without flick
- High luminous efficiency, energy saving and environmental protection
- Modular design, if any lamp does not work, it can be replaced without replacing the whole device
- The position can be adjusted in multiple directions as required
- Application: shopping malls, jewelry, brand clothing, high-end clubs, professional windows, counters and other key lighting places
- Certificate: CE RoHS

- 材质: 优质铝合金型材+PC透鏡
- 發光均勻, 無頻閃
- 發光效率高, 節能環保
- 模塊化設計, 如果有燈組不工作, 可以進行模塊更換, 無需更換整個燈組
- 照射位置可根據需要進行多個方位調整
- 應用場所: 商場、珠寶首飾、品牌服飾、高檔會所、專業櫥窗、櫃檯等重點照明場所
- 證書: CE RoHS



Flick Free
(無閃頻)
保護視力

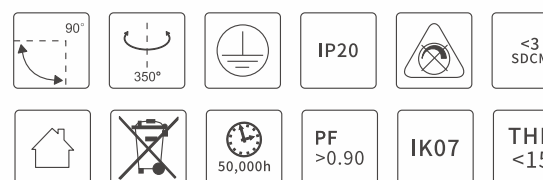

Specification 產品規格 >>

Model 型號	Voltage 電壓 (V)	Power 功率 (W)	Lumen Output 輸出流明 (Lm/W)	Color Rendering 顯色度 (CRI)	Colour Temp 色溫 (K)	Life Time 壽命 (H)	Beam Angle 光束角 (°)	Working temperature 工作溫度 (°C)	Size 尺寸 (mm)
TL-A15-H108E-F1R	100~240	15	100	>80	2700/3000/4000/5000	50000	15/24/38/60	-20~45	Φ90*180
TL-A20-H108E-F1R	100~240	20	100	>80	2700/3000/4000/5000	50000	15/24/38/60	-20~45	Φ90*180
TL-A30-H108E-F1R	100~240	30	100	>80	2700/3000/4000/5000	50000	15/24/38/60	-20~45	Φ90*180

- Light efficiency (lm/W), Power (W), Color Rendering Index (CRI), Size Can be customized according to customer needs
- Our Standard Power factor (PF) > 0.9 and Total harmonic index THD < 15%, According to customer requirements can produce a lower THD < 10%
- This type of certification is issued by a government-approved laboratory for Safety certification, Fire testing, Restriction of Hazardous Substances (RoHS), Photobiological safety of lamps and lamp systems. (an Exemption Group) and other test certifications to ensure product quality
- 光效 (lm/W)、功率 (W)、顯色指數 (CRI)、長度, 可根據客戶需求定制
- 此型號標準之功率因素 (PF) > 0.9, 總諧波指數 THD < 15%, 可按客戶需要生產低總諧波指數 < 10%
- 此型號認證由可實驗室發出之安全認證消防測試, 環保物料 (RoHS), 光生物安全為 Exemption Group 及其它測試, 保證客戶使用更安心滿意