

LED LIGHTING SERIES

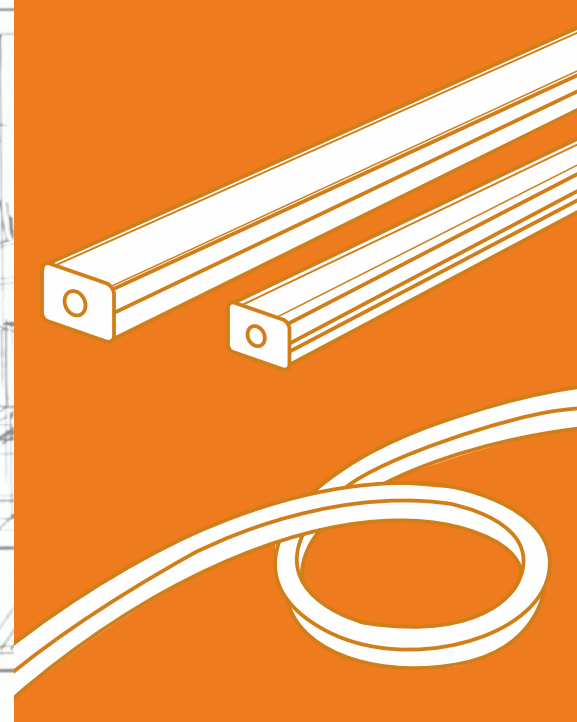

CATALOG

Kitchen and Cabinet Lights

iLighting Global Enterprise Co., Ltd.
www.ilighting.com.hk



iLighting Global Enterprise Co., Ltd.

Office Address: Room B3, 18/F Bonsun Industrial Building,
364-366 Sha Tsui Road, Tsuen Wan, HongKong

Phone: 852-3107 7500

Fax: 852-3544 0462

Email: info@ilighting.com.hk

Website: www.ilighting.com.hk



KITCHEN AND CABINET LIGHT

LED Lighting Series

CONTENTS



LED
Lighting
Series

Company Profile 公司簡介

1-2

Lighting Basic Concept 照明基本概念

3-8

Thermal Conductive LED Strip 導熱燈條

9-13

Aluminum LED Strip LED鋁燈條

14-29

Soft Light Strip Series 軟光條系列

30-35

Transparent waterproof series 透明防水系列

36-39

Neon Light Series 霓虹燈系列

40-56

Cabinet Light Series 櫃燈系列

57-64

A

thermal conductive
LED strip
導熱燈條



P.10
CBL - P1010



P.11
CBL - P1013



P.12
CBL - P0707



P.13
CBL - P1013-RGB

B

aluminum LED strip
LED鋁燈條

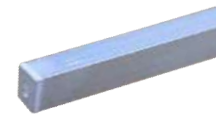

P.15
CBL - A1013



P.16
CBL - A3030



P.17
CBL - A0809



P.18
CBL - A1110



P.19
CBL - A1418



P.20
CBL - A1713



P.21
CBL - A2008



P.22
CBL - A2021



P.23
CBL - A1010-S



P.24
CBL - C2310L



P.25
CBL - C2408L



P.26
CBL - C1515L



P.27
CBL - C1808L



P.28
CBL - C1712L

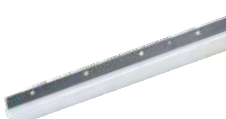

P.29
CBL - UVC

C

soft light strip series
軟光條系列



P.31
5050 Light Belt - Monochrome



P.32
Glue Water proof



P.33
RGB Waterproofing



P.34
Monochrome/double row



P.35
Double Color

D

transparent
waterproof series
透明防水系列



P.37
IP65 Hollow Light Belt



P.38
IP67 Hollow Light Belt



P.39
IP68 Solid Light Strip

E

neon light series
霓虹燈系列



P.41
The Neon Light

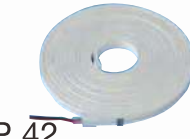

P.42
T5 Series Neon Light

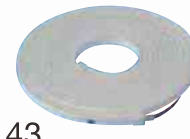

P.43
T6 Series Neon Light

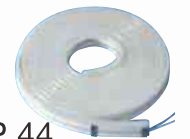

P.44
T7 Series Neon Light



P.45
T8 Series Neon Light

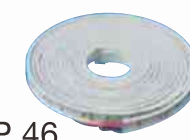

P.46
High Efficiency Light Strip



P.47
T10 Series Neon Light

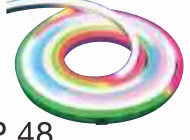

P.48
T10 Series Neon Light

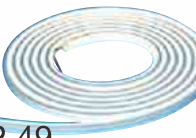

P.49
T10 Series Neon Light



P.50
T12 Series Neon Light



P.51
T12 Series Neon Light



P.52
T12 Series Neon Light



P.53
T15 Series Neon Light



P.54
T15 Series Neon Light



P.55
T15 Series Neon Light



P.56
LED Flex Neon Light

F

cabinet light series
櫃燈系列



P.58
KBL-C



P.59
KBL-S



P.60
KBL-C



P.61
KBL-IB



P.62
KBL-0302



P.63
KBL-0401-PIR



P.64
KBL-0303

Company Profile

公司簡介

ABOUT US 關於我們

iLIGHTING Global Enterprise Co. Ltd. emerges as a professional and high-end lighting designer, manufacturer and supplier established in Hong Kong and Mainland China under the Brand name 'iLighting' since 2007. The company is also a strategic OEM/ODM partner of many organization-wide lighting brands. The company devotes herself in the development, manufacturing and marketing of green, low-carbon and energy-saving lighting products. With continuous investment on R&D, we are proud to provide a wide range of LED products and work with worldwide partners in developing and managing Energy Management System (EMS) through the application of 5G and WiFi technology.

iLIGHTING智能環球企業有限公司成立於2007年是一家集高端照明設計、製造和供應為一體的專業照明公司，自2007年起在香港和中國大陸以“iLighting”的名字成立。公司也是許多照明品牌的戰略性OEM/ODM合作夥伴。公司致力於綠色、低碳、節能照明產品的開發、製造和銷售。憑藉對研發的持續投資，我們自豪地提供範圍廣泛的LED產品，並通過應用5G和WiFi科技與全球合作夥伴合作開發和管理能源管理系統(EMS)。

Product Capacity 生產能力

- LED lighting with integrated design and built-in advanced electronic driver for building lighting retrofit.
- LED indoor and outdoor lighting with internal and external drivers.
- LED lighting emergency fitting and charging packs.
- Extra long life LED lamps for high power high bay and flood lights.
- Total system solution for dimming lighting control deploying WiFi, DALI, Lonwork, Bluetooth 4.0, Zigbee technologies.
- OEM / ODM energy saving lighting as required by clients for new and retrofit installation.
- Total Energy Management Solution for Intelligent Building Management.
- LED照明與集成設計和內置先進的電子驅動器，用於建築照明改造。
- 室內和室外LED照明，有內部和外部驅動器。
- LED照明應急配件和充電器。
- 超長壽命LED燈，適用於大功率高位燈和泛光燈。
- 全系統調光照明控制解決方案，採用WiFi、DALI、Lonwork, Bluetooth 4.0, Zigbee 通訊技術。
- OEM/ODM節能照明，可根據客戶的要求進行更新改造。
- 智能建築管理總能源管理解決方案。

Our Mission 我們的使命

We look to serve our client with the best quality of products and viable solutions of energy management system through intelligent system integration. Product adaptability is our strength ; continuous improvement is our norm of work and meeting customer satisfaction is our goal.

我們希望通過智能系統集成，為客戶提供最優質的產品和可行的能源管理系統解決方案。產品適應性是我們的優勢，持續改進是我們的工作準則，讓客戶滿意是我們的目標。

Our Advantages 我們的優勢

- Excellent after-sale services.
- OEM and ODM for global lighting companies.
- Flexible design and tailor-made products to suit retrofit projects.
- 優良的售後服務。
- 為全球照明公司提供OEM和ODM。
- 靈活的設計和訂制的產品，以適應更新改造項目。



Office Address:
Room B3, 18/F Bonsun Industrial Building, 364-366 Sha Tsui Road, Tsuen Wan, HongKong

Phone: 852-3107 7500

Fax: 852-3544 0462

E-mail: info@ilighting.com.hk

Website: www.ilighting.com.hk

Our Lighting can provide Features

我們的照明可以……

KITCHEN AND CABINET LIGHT

▶ Color Rendering Index 顯色度



	Shop	Kitchen	Commercial
CRI	97	93	> 80

▶ Cutting Strip 切割帶

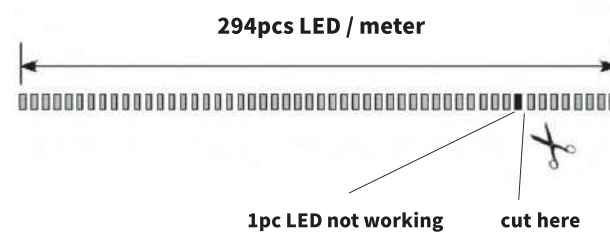

Minimum cutting width < 3mm



▶ Flicker-Free 無閃頻

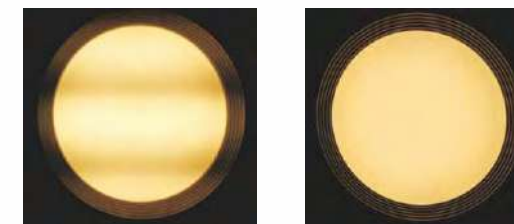

Kitchen Light = Flicker Free

▶ Thermal Conductive Plastic Strip 導熱膠條

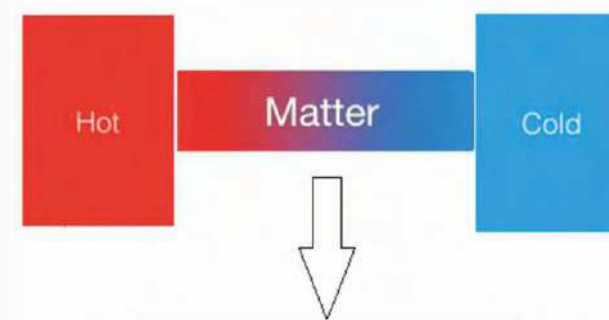

Thermal Conductive

▶ Fire Retardant & 3 Side Rich Color 阻燃且三面豐富色彩

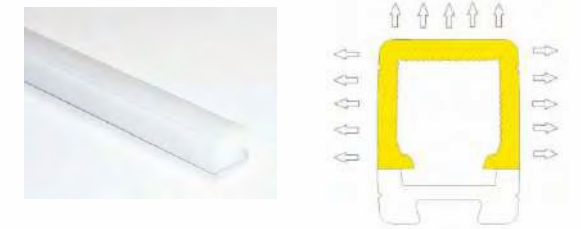

Comply with Part A11 of FSD Regulation PPA104 (4th rev) and B3 Regulation PPA 104A (4th rev)

▶ Change Color and Dimming 更改顏色和調光

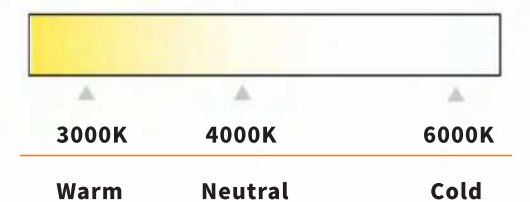



Lighting Basic Concept

照明基本概念



Lumen 流明

Lumen 實際上是代表著光的強度，也就是光通量(Luminous flux)即指光源在某單位時間內所發出之光線總數量。一般稱作光束)的單位，簡而言之，流明就是光束照在物體表面的量。

Lumen actually represents the intensity of lights. that is, the luminous flux(Luminous Flux) refers to the unit of the total amount of light emitted by a light source in a unit time, generally referred to as the light beam. In short, lumens is the light beam Amount on the surface of the object.

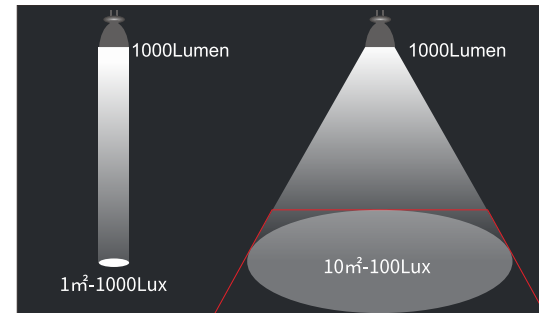

Color Rendering Index 顯色度

顯色度以Ra來表示，天然光的顯色度為100 Ra，顯色度越接近100Ra，我們看到的顏色就越接近物體的自然原色。也就是顏色逼真的程度，顯色度高 我們所看到的顏色也就是較接近自然原色，顯色度低對於顏色的表現較差，所看到的顏色偏差也延遲。

Color rendering is represented by Ra, the color rendering of natural light is 100 Ra, the closer the color rendering is to 100 Ra, the color we see is closer to the natural primary color of the object. Color is realistic. The degree of color rendering is high. The color we see is close to natural primary color, low color rendering, poor performance for color, The color deviation seen is also delayed.

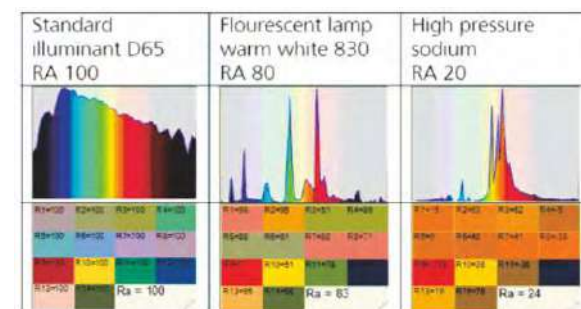









Color Temperature 色溫

色溫及不同色溫應用什麼環境——以絕對溫度 K(kelvin)來表示，色溫度 3000k以下時，光色有偏紅的現象(黃光)，給予一種溫暖、親切、舒適的感覺；色溫度超過 5000k時，顏色則偏向藍光(白光)，給人一種清冷的感覺，令環境變得清淨和寧靜。

通常亞熱帶人較喜歡清冷 4000k以上，而寒帶的人較喜歡 4000k以下的色溫度。

Color temperature and what environment is used for different color temperatures-expressed in absolute temperature K (kelvin), when the color temperature is below 3000k, the light color has a reddish phenomenon (yellow light), giving a warm, friendly, comfortable feeling; color temperature exceeds 5000k At this time, the color is biased towards blue light (white light), giving a cool feeling. Make the environment clear and peaceful.

Generally, people in the subtropics prefer cold temperatures above 4000k, while those in the cold regions prefer colors below 4000k.

WB SETTINGS	COLOR TEMPERATURE	LIGHT SOURCES
	10000-15000K	Clear Blue Sky
	6500-8000K	Cloudy Sky / Shade
	6000-7000K	Noon Sunlight
	5500-6500K	Average Daylight
	5000-5500K	Electronic Flash
	4000-5000K	Fluorescent Light
	3000-4000K	Early AM/ Late PM
	2500-3000K	Domestic Lighting
	1000-2000K	Candle Flame



Fire Proof Material 物料防火等級

塑料阻燃等級由 HB, V-2, V-1向V-0逐級遞增。

HB: UL94標準中最低的阻燃等級，要求對於3到13毫米厚的樣品，燃燒速度小於 40毫米每分鐘；小於 3毫米厚的樣品，燃燒速度小於 70毫米每分鐘；或者在 100毫米的標誌前熄滅。

V-2: 對樣品進行兩次 10秒的燃燒測試後，火焰在 30秒內熄滅，可以引燃 30cm下方的藥棉。

V-1: 對樣品進行兩次 10秒的燃燒測試後，火焰在 30秒內熄滅，不能引燃 30cm下方的藥棉。

V-0: 對樣品進行兩次 10秒的燃燒測試後，火焰在 10秒內熄滅，不能有燃燒物掉下。

Plastic flame retardant grades are gradually increased from HB, V-2, V-1 to V-0.

HB: The lowest flame retardant grade in the UL94 standard, Require for 3 to 13mm thick samples with a burning rate of less than 40 mm per minute; less than 3 mm thick samples with a burning rate of less than 70 mm per minute; or stop at 100 mm sign.

V-2: After two 10-second burn tests on the sample, the

flame stops at 30 seconds, would ignite cotton wool below 30cm.

V-1: After two 10-second fire tests on the sample, the flame was at 30 seconds Inside goes out. Would not ignite cotton wool below 30cm.

V-0: After two 10-second burn tests on the sample, the flame stops at 10 seconds. No burning substances should fall off.



Power Factor 功率因數

日常使用的交流電壓是電壓高低不斷地在變化的，理想情況下，電壓和電流相位完全同相，Pf=1。同步下最大的發揮電線的傳輸效率。這情況下用電設備所使用的所有功率叫稱功率。

電器的最大電流瞬間比電網最高電壓的瞬時提前或滯後，那就

會降低電線的效率。由於其不同步，電線內阻造成額外的功率損耗，這部分損耗的功率稱無功率。

The AC voltage used in daily life is constantly changing in voltage, ideally in the following, voltage and current are called in-phase, and PF= 1. Can make the most of the wire transmission efficiency. In this case, all the power used by the electrical equipment is called active power.

The maximum current of the appliance is instantaneously earlier or later than the instant of the maximum voltage of the power grid. Will reduce the efficiency of the wire. Due to its non-synchronization, the internal resistance of the wire causes additional power loss, the power lost in this part is called no power. Therefore, we generally

want to make the electrical equipment as much as possible. The highest voltage is synchronized. The closer the PF is to 1, the more synchronized the wire loss is the more environmentally friendly.

Minimum Allowable Power Factor For Non-Directional LED Lamp With Integrated Driver

Rated Lamp Wattage(LW)	minimum allowable power factor
LW ≤ 5W	0.5
5W < LW ≤ 25W	0.7
LW > 25W	0.9

Minimum Allowable Power Factor For Directional LED Lamp With Integrated Driver

Rated Lamp Wattage(LW)	minimum allowable power factor
LW ≤ 5W	0.5
5W < LW ≤ 25W	0.7
LW > 25W	0.9

Information refer to Hong Kong Voluntary Energy Efficiency Labelling for LED lamp-January 2017 EMSD (Electrical and Mechanical Services Department)

Nominal CCT	Target CCT and tolerance(K)	Target DUV and tolerance(K)
2700k	2725 ± 145	0.000 ± 0.006
3000k	3045 ± 175	0.000 ± 0.006
3500k	3465 ± 245	0.000 ± 0.006
4000k	3985 ± 275	0.001 ± 0.006
4500k	4503 ± 243	0.001 ± 0.006
5000k	5026 ± 283	0.002 ± 0.006
5700k	5665 ± 355	0.002 ± 0.006
6500k	6530 ± 510	0.003 ± 0.006
Flexible CCT(2700-6500k)	T _r ± ΔT _r	D _v ± 0.006

The LED lamp must have one of the rated Correlated Colour Temperatures (CCTs) including 2700K,3000K,3500K,4000K,4500K,5000K,5700K,6500K and flexible CCT consistent with the 7-step chromaticity, quadrangles and Duv tolerances as indicated in Table 1. The measured initial CCT and initial DUV shall be within the tolerances of target CCT and target DUV of the selected rated CCT.

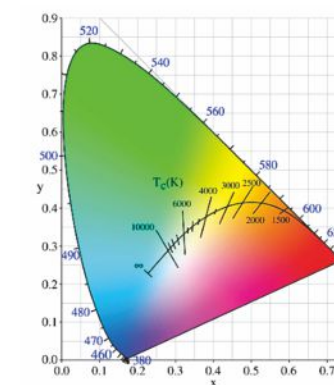

Stroboscopic Suppression 頻閃抑制

理想的光源亮度是鎮流後之直流電壓恆定不變的，這就是理論上的絕對無頻閃。實際上我們平常使用的燈具直流電壓都不會真正的恆定不變，週期的亮度高低變化程度就是頻率。

市面常見LED驅動電路，頻閃深度最大的頻率一般都是100HZ左右。因為PWM高頻是調製在50HZ整流後的電壓上。實際燈具中，任何的頻率上都有一定的頻閃深度（最亮的亮

度和最暗的亮度之差）。那麼，這裡就存在一個頻閃深度最大的時候所對應的頻閃頻率。還有就是最大的頻閃深度值。

頻閃頻率越高對人的影響越小，頻閃深度越小對人的影響越小，總體來說頻閃深度越小對人降低或消除導致視力疲勞的低頻率光，減輕眼睛負擔，關愛眼睛。

Ideal light source brightness is constant, which is absolute no stroboscopic depth. In fact, the brightness of the lamps we usually install will not be truly stable. The degree of change in the brightness within the period is the frequency.

The common LED drive circuit in the market has the stroboscopic depth at frequency 100 HZ or so. This is because PWM high frequency is modulated on the voltage after 50 HZ rectification. In actual lamps, there will be a certain stroboscopic depth at any frequency. (The difference between the greatest brightest and smallest brightness). Well, there would be the strobe frequency corresponding to the maximum stroboscopic depth, that has the biggest strobe depth value.

The higher the strobe frequency, the smaller the impact is on peoples. As a conclusion, the lower the stroboscopic depth can reduce or eliminate low-frequency light vision fatigue that reduces the burden on the eyes and cares about eye health.

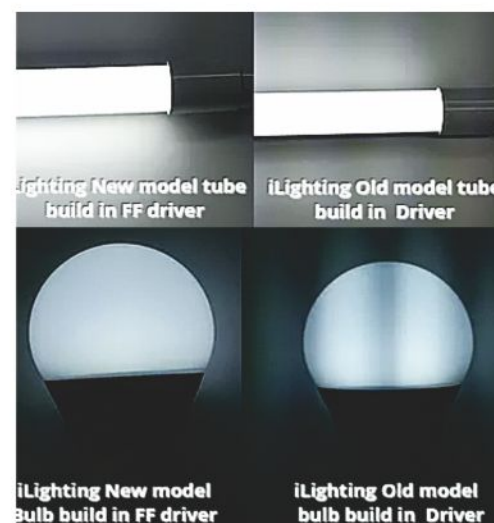

LED International standard for chromaticity difference

LED 光源色度差異之國際標準

Chromaticity Tolerances

Quadrangles

— In both ΔCCT and Duv directions

— Approximately equal to 7-step MacAdam ellipses



Light source efficiency lm/w (lumen efficiency)

光源效率 lm/w (流明效率)

光源的效率取決於其所發出的光的流明除以起耗電量所得值LED光亮度，並非似功耗(W)度量，而是以流明輸出(lm)來決定。

iLighting LED 流明效益高，更有歐洲B級能源標籤，保證節電環保。

The efficiency of a light source depends on the lumen of the light it emits divided by the power consumption LED brightness is not similar to wattage (W) measurement, but measured in lumens output (lm) Decide.

iLighting LED Lumen has high lumen efficiency, and it also has obtained European B energy label to ensure power saving and environmental protection.

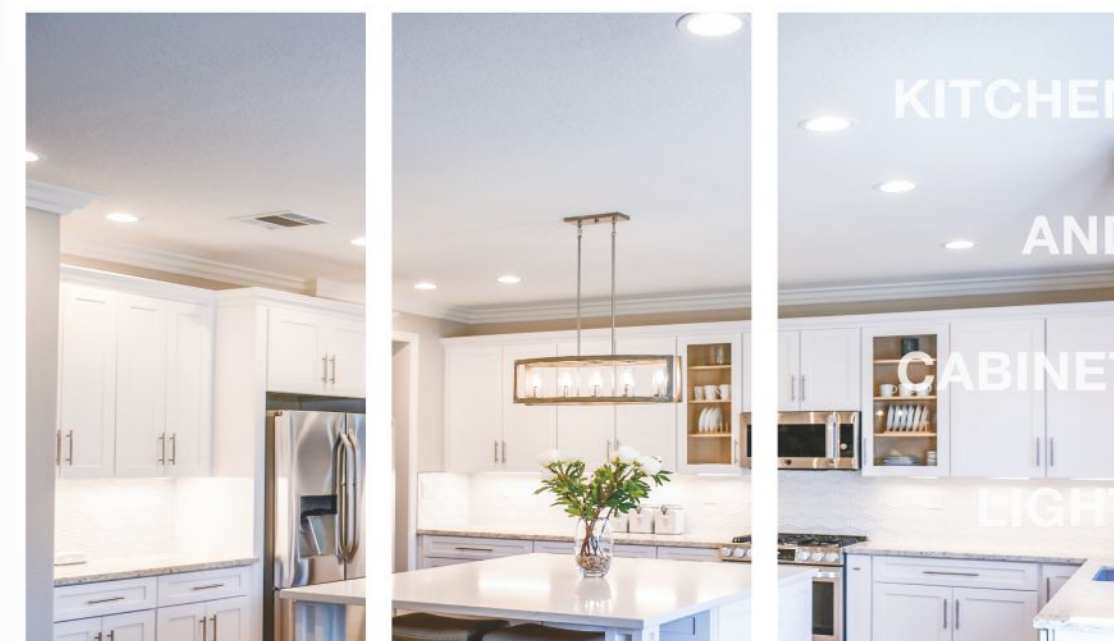
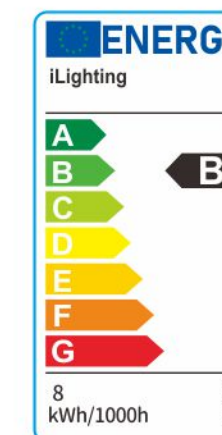

Thermal Conductive LED Light Strip

Series Type: P1010



Flick Free
(無閃頻)
保護視力

Features 產品特點 >>

- Size: 9.9 mm (W) x 9.9 mm (H)
- Uniform light emission, 270 degree (3-sectional) lighting output
SPM Design – power circuit protection to cut off individual LEDs when mal-functioned
- Minimum cutting length < 3mm,
- Thermal conductive plastic to maximize heat dissipation
- Installation in serial for seamless lighting output
- Uniform light emission without LED spot
- Application: Kitchen cabinet, Bathroom cabinet, Closet, Show cabinet, Retail chop, etc



- 尺寸9.9毫米(寬)x9.9毫米(高)
- 最小切割長度<3mm
- 使用SPM設計-電源電路保護,在故障時切斷單個LED
- 採用最佳散熱的導熱塑膠
- 串聯安裝以實現無縫照明輸出
- 發光均勻,無LED光點
- 應用:廚櫃、浴室櫃、衣櫃、展示櫃、零售店等

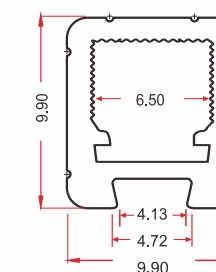

Specification 產品規格 >>

Model 型號	DC Voltage 電壓 (V)	Wattage 功率 (W)	Length 長度 (mm)	Lamp Life 光度壽命 (Hrs)	Colour Temp 色溫 (K)	Lumen Output 輸出流明 (Lm/W)	Color Rendering 顯色度 (CRI)	Beam Angle 光速角度 (°)	Operating Temperature 工作溫度 (°C)
CBL-P1010-S1004-109A	12/24	4	1000	50000	2700/3000/4000/6500	100	>90	270	-20~+45
CBL-P1010-S1008-109A	12/24	8	1000	50000	2700/3000/4000/6500	100	>90	270	-20~+45
CBL-P1010-S1205-109A	12/24	5	1200	50000	2700/3000/4000/6500	100	>90	270	-20~+45
CBL-P1010-S1210-109A	12/24	10	1200	50000	2700/3000/4000/6500	100	>90	270	-20~+45

- Light efficiency (lm/W), Power (W), Color Rendering Index (CRI), Length Can be customized according to customer needs
- Our Standard Power factor (PF) > 0.9 and Total harmonic index THD < 15%, According to customer requirements can produce a lower THD < 10%
- This type of certification is issued by a government-approved laboratory for Safety certification, Fire testing, Restriction of Hazardous Substances (RoHS), Photobiological safety of lamps and lamp systems. (an Exemption Group) and other test certifications to ensure product quality

- 光效 (lm/W)、功率 (W)、顯色指數 (CRI)、長度, 可根據客戶需求定制
- 此型號標準之功率因素 (PF) > 0.9, 總諧波指數 THD < 15%, 可按客戶需要生產低總諧波指數 < 10%
- 此型號認證由可實驗室發出之安全認證消防測試, 環保物料 (RoHS), 光生物安全為 Exemption Group 及其它測試, 保證客戶使用更安心滿意

Thermal Conductive LED Strip

LED導熱燈條

Thermal Conductive LED Light Strip

Series Type: P1013



Flick Free
(無閃頻)
保護視力

Features 產品特點 >>

- Size: 10.00mm (W) x 13.00mm (H)
- Uniform light emission, 270 degree (3-sectional) lighting output
- SPM Design – power circuit protection to cut off individual LEDs when mal-functioned
- Minimum cutting length < 3mm,
- Thermal conductive plastic to maximize heat dissipation
- Installation in serial for seamless lighting output
- Uniform light emission without LED spot
- Application: Kitchen cabinet, Bathroom cabinet, Closet, Show cabinet, Retail chop, etc



- 尺寸: 10.00毫米(寬)x13.00毫米(高)
- 最小切割長度<3mm
- 使用SPM設計-電源電路保護,在故障時切斷單個LED
- 採用最佳散熱的導熱塑膠
- 串聯安裝以實現無縫照明輸出
- 發光均勻,無LED光點
- 應用:廚櫃、浴室櫃、衣櫃、展示櫃、零售店等

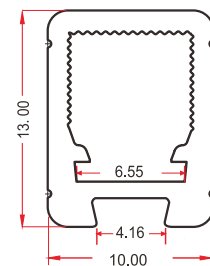

Unit : mm

Specification 產品規格 >>

Model 型號	DC Voltage 電壓 (V)	Wattage 功率 (W)	Length 長度 (mm)	Lamp Life 光度壽命 (Hrs)	Colour Temp 色溫 (K)	Lumen Output 輸出流明 (Lm/W)	Color Rendering 顯色度 (CRI)	Beam Angle 光速角度 (°)	Operating Temperature 工作溫度 (°C)
CBL-P1013-S1004-109A	12/24	4	1000	50000	2700/3000/4000/6500	100	>90	270	-20~+45
CBL-P1013-S1008-109A	12/24	8	1000	50000	2700/3000/4000/6500	100	>90	270	-20~+45
CBL-P1013-S1205-109A	12/24	5	1200	50000	2700/3000/4000/6500	100	>90	270	-20~+45
CBL-P1013-S1210-109A	12/24	10	1200	50000	2700/3000/4000/6500	100	>90	270	-20~+45

- Light efficiency (lm/W), Power (W), Color Rendering Index (CRI), Length Can be customized according to customer needs
- Our Standard Power factor (PF) > 0.9 and Total harmonic index THD < 15%, According to customer requirements can produce a lower THD < 10%
- This type of certification is issued by a government-approved laboratory for Safety certification, Fire testing, Restriction of Hazardous Substances (RoHS), Photobiological safety of lamps and lamp systems. (an Exemption Group) and other test certifications to ensure product quality

- 光效 (lm/W)、功率 (W)、顯色指數 (CRI)、長度, 可根據客戶需求定制
- 此型號標準之功率因素 (PF) > 0.9, 總諧波指數 THD < 15%, 可按客戶需要生產低總諧波指數 < 10%
- 此型號認證由可實驗室發出之安全認證消防測試, 環保物料 (RoHS), 光生物安全為 Exemption Group 及其它測試, 保證客戶使用更安心滿意

Thermal Conductive LED Light Strip

Series Type: P0707



Flick Free
(無閃頻)
保護視力

Features 產品特點 >>

- Size: 6.99mm (W) x 6.99mm (H)
- Uniform light emission, 270 degree (3-sectional) lighting output
- SPM Design – power circuit protection to cut off individual LEDs when mal-functioned
- Minimum cutting length < 3mm,
- Thermal conductive plastic to maximize heat dissipation
- Installation in serial for seamless lighting output
- Uniform light emission without LED spot
- Application: Kitchen cabinet, Bathroom cabinet, Closet, Show cabinet, Retail chop, etc



- 尺寸: 6.99毫米(寬)x6.99毫米(高)
- 最小切割長度<3mm
- 使用SPM設計-電源電路保護,在故障時切斷單個LED
- 採用最佳散熱的導熱塑膠
- 串聯安裝以實現無縫照明輸出
- 發光均勻,無LED光點
- 應用:廚櫃、浴室櫃、衣櫃、展示櫃、零售店等

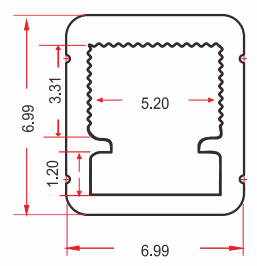

Unit : mm

Specification 產品規格 >>

Model 型號	DC Voltage 電壓 (V)	Wattage 功率 (W)	Length 長度 (mm)	Lamp Life 光度壽命 (Hrs)	Colour Temp 色溫 (K)	Lumen Output 輸出流明 (Lm/W)	Color Rendering 顯色度 (CRI)	Beam Angle 光速角度 (°)	Operating Temperature 工作溫度 (°C)
CBL-P0707-S1004-109A	12/24	4	1000	50000	2700/3000/4000/6500	100	>90	270	-20~+45
CBL-P0707-S1008-109A	12/24	8	1000	50000	2700/3000/4000/6500	100	>90	270	-20~+45
CBL-P0707-S1205-109A	12/24	5	1200	50000	2700/3000/4000/6500	100	>90	270	-20~+45
CBL-P0707-S1210-109A	12/24	10	1200	50000	2700/3000/4000/6500	100	>90	270	-20~+45

- Light efficiency (lm/W), Power (W), Color Rendering Index (CRI), Length Can be customized according to customer needs
- Our Standard Power factor (PF) > 0.9 and Total harmonic index THD < 15%, According to customer requirements can produce a lower THD < 10%
- This type of certification is issued by a government-approved laboratory for Safety certification, Fire testing, Restriction of Hazardous Substances (RoHS), Photobiological safety of lamps and lamp systems. (an Exemption Group) and other test certifications to ensure product quality

- 光效 (lm/W)、功率 (W)、顯色指數 (CRI)、長度, 可根據客戶需求定制
- 此型號標準之功率因素 (PF) > 0.9, 總諧波指數 THD < 15%, 可按客戶需要生產低總諧波指數 < 10%
- 此型號認證由可實驗室發出之安全認證消防測試, 環保物料 (RoHS), 光生物安全為 Exemption Group 及其它測試, 保證客戶使用更安心滿意

DMX RGBW LED Cabinet Light Strip

Series Type: P1013-RGB

Features 產品特點 >>

- Size: 10 mm (W) x 13 mm (H)
- Uniform light emission, 270 degree (3-sectional) lighting output
- SPM Design – power circuit protection to cut off individual LEDs when mal-functioned
- Minimum cutting length < 3mm,
- Thermal conductive plastic to maximize heat dissipation
- Installation in serial for seamless lighting output
- Uniform light emission without LED spot
- Control Protocol : DMX512 Control RGB +W
- Application: Show cabinet, Retail chop , etc

- 尺寸: 10毫米(寬)x13毫米(高)
- 最小切割長度 ≤ 83mm
- 使用SPM設計-電源電路保護, 在故障時切斷單個LED
- 採用最佳散熱的導熱塑膠
- 串聯安裝以實現無縫照明輸出
- 發光均勻, 無LED光點
- 控制協議: DMX512控制RGB + W
- 應用: 展示櫃、零售店等

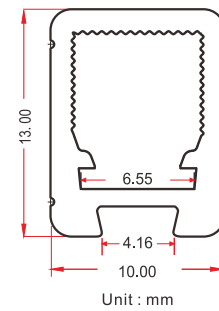
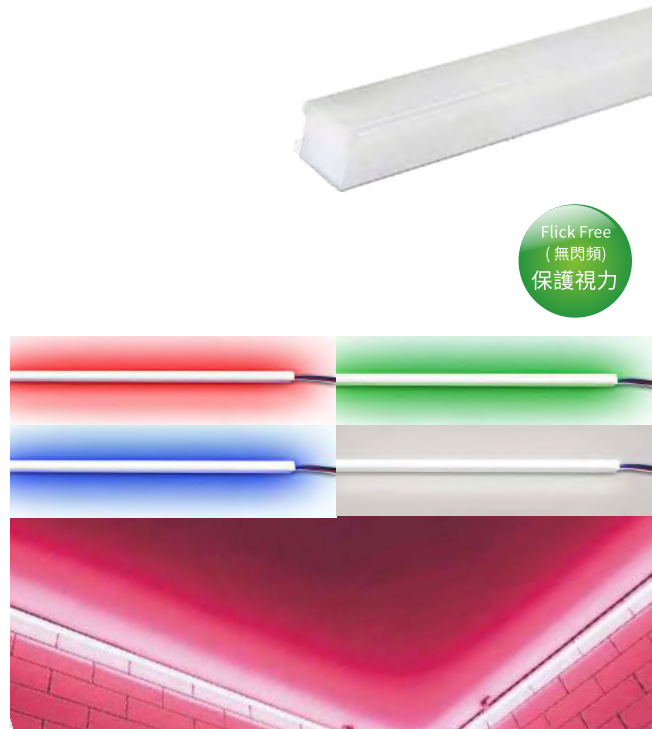

Specification 產品規格 >>

Model 型號	DC Voltage 電壓 (V)	Wattage 功率 (W)	Length 長度 (mm)	Lamp Life 光度壽命 (Hrs)	Colour Temp 色溫 (K)	Lumen Output 輸出流明 (Lm/W)	Color Rendering 顯色度 (CRI)	Beam Angle 光速角度 (°)	Operating Temperature 工作溫度 (°C)
CBL-P1013-RGB1004-108A	24	4	1000	50000	Mixing Color	100	>80	270	-20~+45
CBL-P1013-RGB1008-108A	24	8	1000	50000	Mixing Color	100	>80	270	-20~+45
CBL-P1013-RGB1205-108A	24	5	1200	50000	Mixing Color	100	>80	270	-20~+45
CBL-P1013-RGB1210-108A	24	10	1200	50000	Mixing Color	100	>80	270	-20~+45

- Light efficiency (lm/W), Power (W), Color Rendering Index (CRI), Length Can be customized according to customer needs
- Power: Cool white-max10.8W/M, RGB Each Color max 3.6W /M
- Our Standard Power factor (PF) > 0.9 and Total harmonic index THD < 15%, According to customer requirements can produce a lower THD < 10%
- This type of certification is issued by a government-approved laboratory for Safety certification, Fire testing, Restriction of Hazardous Substances (RoHS), Photobiological safety of lamps and lamp systems. (an Exemption Group) and other test certifications to ensure product quality
- 光效 (lm/W)、功率 (W)、顯色指數 (CRI)、長度, 可根據客戶需求定制. 此型號標準功率: 冷白色-max10.8W/M, RGB每種顏色最大3.6W/M
- 此型號標準之功率因素 (PF) > 0.9, 總諧波指數 THD < 15%, 可按客戶需要生產低總諧波指數 < 10%
- 此型號認證由可實驗室發出之安全認證消防測試, 環保物料 (RoHS), 光生物安全為 Exemption Group 及其它測試, 保證客戶使用更安心滿意

Aluminum LED Strip

LED铝燈條

Aluminum LED Strip

Series Type: A1013

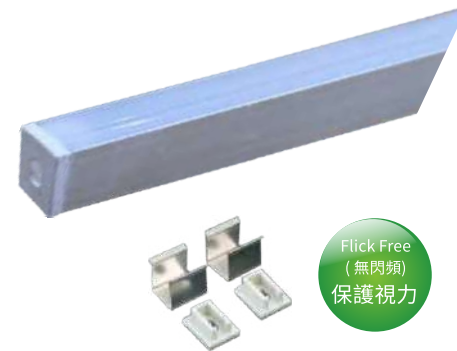

Features 產品特點 >>

- PC cover : milky
- Size:10 mm (W) x 13 mm (H)
- SPM Design – power circuit protection to cut off individual LEDs when mal-functioned
- Aluminum to maximize heat dissipation
- Installation in serial for seamless lighting output
- Uniform light emission without LED spot
- Application: Kitchen cabinet, Bathroom cabinet ,Closet, Show cabinet, Retail shop,etc



- PC蓋: 乳白色
- 尺寸: 10毫米(寬)X13毫米(高)
- 使用SPM設計-電源電路保護, 在故障時切斷單個LED
- 採用鋁框架使散熱最大化
- 串聯安裝以實現無縫照明輸出
- 發光均勻,無LED光點
- 應用: 廚櫃、浴室櫃、壁櫥、展示櫃、零售店等

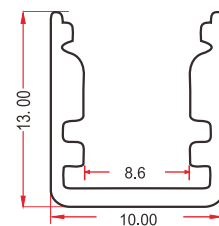

Unit : mm

Specification 產品規格 >>

Model 型號	DC Voltage 電壓	Wattage 功率	Length 長度	Lamp Life 光度壽命	Colour Temp 色溫	Lumen Output 輸出流明	Color Rendering 顯色度	Beam Angle 光速角度	Operating Temperature 工作溫度
	(V)	(W)	(mm)	(Hrs)	(K)	(Lm/W)	(CRI)	(°)	(°C)
CBL-A1013-S1004-109A	12/24	4	1000	50000	2700/3000/4000/6500	100	>90	120	-20~+45
CBL-A1013-S1008-109A	12/24	8	1000	50000	2700/3000/4000/6500	100	>90	120	-20~+45
CBL-A1013-S1205-109A	12/24	5	1200	50000	2700/3000/4000/6500	100	>90	120	-20~+45
CBL-A1013-S1210-109A	12/24	10	1200	50000	2700/3000/4000/6500	100	>90	120	-20~+45

- Light efficiency (lm/W),Power (W),Color Rendering Index (CRI), Length Can be customized according to customer needs
- Our Standard Power factor (PF) > 0.9 and Total harmonic index THD < 15%, According to customer requirements can produce a lower THD < 10%
- This type of certification is issued by a government-approved laboratory for Safety certification, Fire testing, Restriction of Hazardous Substances(RoHS), Photobiological safety of lamps and lamp systems.(an Exemption Group) and other test certifications to ensure product quality

- 光效(lm/W)、功率(W)、顯色指數(CRI)、長度,可根據客戶需求定制
- 此型號標準之功率因素(PF)>0.9,總諧波指數THD<15%,可按客戶需要生產低總諧波指數<10%
- 此型號認證由可實驗室發出之安全認證消防測試,環保物料(RoHS),光生物安全為Exemption Group及其它測試,保證客戶使用更安心滿意

Aluminum LED Strip

Series Type: A3030



Features 產品特點 >>

- PC cover : milky
- Size:30 mm (W) x 30mm (H)
- SPM Design – power circuit protection to cut off individual LEDs when mal-functioned
- Aluminum to maximize heat dissipation
- Installation in serial for seamless lighting output
- Uniform light emission without LED spot
- Application: Kitchen cabinet, Bathroom cabinet ,Closet, Show cabinet, Retail shop,etc



- PC蓋: 乳白色或透明
- 尺寸: 30毫米(寬)X30毫米(高)
- 使用SPM設計-電源電路保護, 在故障時切斷單個LED
- 採用鋁框架使散熱最大化
- 串聯安裝以實現無縫照明輸出
- 發光均勻,無LED光點
- 應用: 廚櫃、浴室櫃、壁櫥、展示櫃、零售店等

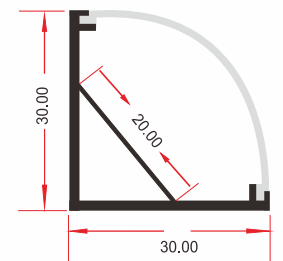

Unit : mm

Specification 產品規格 >>

Model 型號	DC Voltage 電壓	Wattage 功率	Length 長度	Lamp Life 光度壽命	Colour Temp 色溫	Lumen Output 輸出流明	Color Rendering 顯色度	Beam Angle 光速角度	Operating Temperature 工作溫度
	(V)	(W)	(mm)	(Hrs)	(K)	(Lm/W)	(CRI)	(°)	(°C)
CBL-A3030-S1008-109A	12/24	8	1000	50000	2700/3000/4000/6500	100	>90	120	-20~+45
CBL-A3030-S1010-109A	12/24	10	1000	50000	2700/3000/4000/6500	100	>90	120	-20~+45
CBL-A3030-S1210-109A	12/24	10	1200	50000	2700/3000/4000/6500	100	>90	120	-20~+45
CBL-A3030-S1214-109A	12/24	14	1200	50000	2700/3000/4000/6500	100	>90	120	-20~+45

- Light efficiency (lm/W),Power (W),Color Rendering Index (CRI), Length Can be customized according to customer needs
- Our Standard Power factor (PF) > 0.9 and Total harmonic index THD < 15%, According to customer requirements can produce a lower THD < 10%
- This type of certification is issued by a government-approved laboratory for Safety certification, Fire testing, Restriction of Hazardous Substances(RoHS), Photobiological safety of lamps and lamp systems.(an Exemption Group) and other test certifications to ensure product quality

- 光效(lm/W)、功率(W)、顯色指數(CRI)、長度,可根據客戶需求定制
- 此型號標準之功率因素(PF)>0.9,總諧波指數THD<15%,可按客戶需要生產低總諧波指數<10%
- 此型號認證由可實驗室發出之安全認證消防測試,環保物料(RoHS),光生物安全為Exemption Group及其它測試,保證客戶使用更安心滿意

Aluminum LED Strip

Series Type: A0809

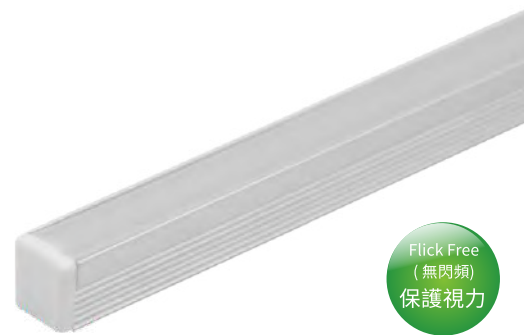

Flick Free
(無閃頻)
保護視力

Features 產品特點 >>

- PC cover : milky
- Size: 7.8mm (W) x 9.0 mm (H)
- SPM Design – power circuit protection to cut off individual LEDs when mal-functioned
- Aluminum to maximize heat dissipation
- Installation in serial for seamless lighting output
- Uniform light emission without LED spot
- Application: Kitchen cabinet, Bathroom cabinet ,Closet, Show cabinet, Retail shop,etc



- PC蓋: 乳白色
- 尺寸: 7.8毫米(寬)X9毫米(高)
- 使用SPM設計-電源電路保護, 在故障時切斷單個LED
- 採用鋁框架使散熱最大化
- 串聯安裝以實現無縫照明輸出
- 發光均勻,無LED光點
- 應用: 廚櫃、浴室櫃、壁櫥、展示櫃、零售店等

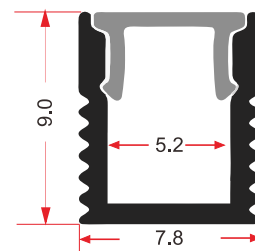

Unit : mm

Specification 產品規格 >>

Model 型號	DC Voltage 電壓 (V)	Wattage 功率 (W)	Length 長度 (mm)	Lamp Life 光度壽命 (Hrs)	Colour Temp 色溫 (K)	Lumen Output 輸出流明 (Lm/W)	Color Rendering 顯色度 (CRI)	Beam Angle 光速角度 (°)	Operating Temperature 工作溫度 (°C)
CBL-A0809-S1004-109A	12/24	4	1000	50000	2700/3000/4000/6500	100	>90	120	-20~+45
CBL-A0809-S1008-109A	12/24	8	1000	50000	2700/3000/4000/6500	100	>90	120	-20~+45
CBL-A0809-S1205-109A	12/24	5	1200	50000	2700/3000/4000/6500	100	>90	120	-20~+45
CBL-A0809-S1210-109A	12/24	10	1200	50000	2700/3000/4000/6500	100	>90	120	-20~+45

- Light efficiency (lm/W),Power (W),Color Rendering Index (CRI), Length Can be customized according to customer needs
- Our Standard Power factor (PF) > 0.9 and Total harmonic index THD < 15%, According to customer requirements can produce a lower THD < 10%
- This type of certification is issued by a government-approved laboratory for Safety certification, Fire testing, Restriction of Hazardous Substances(RoHS), Photobiological safety of lamps and lamp systems.(an Exemption Group) and other test certifications to ensure product quality

- 光效 (lm/W)、功率 (W)、顯色指數 (CRI)、長度, 可根據客戶需求定制
- 此型號標準之功率因素 (PF) > 0.9, 總諧波指數 THD < 15%, 可按客戶需要生產低總諧波指數 < 10%
- 此型號認證由可實驗室發出之安全認證消防測試, 環保物料 (RoHS), 光生物安全為 Exemption Group 及其它測試, 保證客戶使用更安心滿意

Aluminum LED Strip

Series Type: A1110



Flick Free
(無閃頻)
保護視力

Features 產品特點 >>

- PC cover : milky
- Size: 10.8 mm (W) x 10mm (H)
- SPM Design – power circuit protection to cut off individual LEDs when mal-functioned
- Aluminum to maximize heat dissipation
- Installation in serial for seamless lighting output
- Uniform light emission without LED spot
- Application: Kitchen cabinet, Bathroom cabinet ,Closet, Show cabinet, Retail shop,etc



- PC蓋: 乳白色或透明
- 尺寸: 10.8毫米(寬)X10毫米(高)
- 使用SPM設計-電源電路保護, 在故障時切斷單個LED
- 採用鋁框架使散熱最大化
- 串聯安裝以實現無縫照明輸出
- 發光均勻,無LED光點
- 應用: 廚櫃、浴室櫃、壁櫥、展示櫃、零售店等

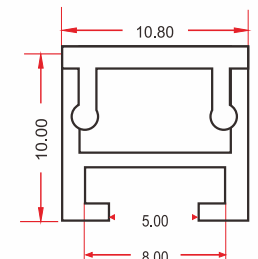

Unit : mm

Specification 產品規格 >>

Model 型號	DC Voltage 電壓 (V)	Wattage 功率 (W)	Length 長度 (mm)	Lamp Life 光度壽命 (Hrs)	Colour Temp 色溫 (K)	Lumen Output 輸出流明 (Lm/W)	Color Rendering 顯色度 (CRI)	Beam Angle 光速角度 (°)	Operating Temperature 工作溫度 (°C)
CBL-A1110-S1004-108A	12/24	4	1000	50000	2700/3000/4000/6500	100	>90	120	-20~+45
CBL-A1110-S1008-109A	12/24	8	1000	50000	2700/3000/4000/6500	100	>90	120	-20~+45
CBL-A1110-S1205-109A	12/24	5	1200	50000	2700/3000/4000/6500	100	>90	120	-20~+45
CBL-A1110-S1210-109A	12/24	10	1200	50000	2700/3000/4000/6500	100	>90	120	-20~+45

- Light efficiency (lm/W),Power (W),Color Rendering Index (CRI), Length Can be customized according to customer needs
- Our Standard Power factor (PF) > 0.9 and Total harmonic index THD < 15%, According to customer requirements can produce a lower THD < 10%
- This type of certification is issued by a government-approved laboratory for Safety certification, Fire testing, Restriction of Hazardous Substances(RoHS), Photobiological safety of lamps and lamp systems.(an Exemption Group) and other test certifications to ensure product quality

- 光效 (lm/W)、功率 (W)、顯色指數 (CRI)、長度, 可根據客戶需求定制
- 此型號標準之功率因素 (PF) > 0.9, 總諧波指數 THD < 15%, 可按客戶需要生產低總諧波指數 < 10%
- 此型號認證由可實驗室發出之安全認證消防測試, 環保物料 (RoHS), 光生物安全為 Exemption Group 及其它測試, 保證客戶使用更安心滿意

Aluminum LED Strip

Series Type: A1418



Flick Free
(無閃頻)
保護視力

Features 產品特點 >>

- PC cover : milky
- Size:14 mm (W) x 18.5 mm (H)
- SPM Design – power circuit protection to cut off individual LEDs when mal-functioned
- Aluminum to maximize heat dissipation
- Installation in serial for seamless lighting output
- Uniform light emission without LED spot
- Application: Kitchen cabinet, Bathroom cabinet ,Closet, Show cabinet, Retail shop,etc



- PC蓋:乳白色
- 尺寸:14毫米(寬)X18.5毫米(高)
- 使用SPM設計-電源電路保護,在故障時切斷單個LED
- 採用鋁框架使散熱最大化
- 串聯安裝以實現無縫照明輸出
- 發光均勻,無LED光點
- 應用:廚櫃、浴室櫃、壁櫥、展示櫃、零售店等

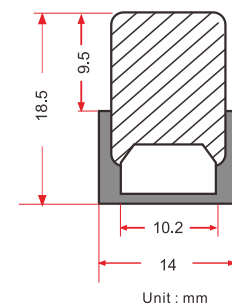

Specification 產品規格 >>

Model 型號	DC Voltage 電壓 (V)	Wattage 功率 (W)	Length 長度 (mm)	Lamp Life 光度壽命 (Hrs)	Colour Temp 色溫 (K)	Lumen Output 輸出流明 (Lm/W)	Color Rendering 顯色度 (CRI)	Beam Angle 光速角度 (°)	Operating Temperature 工作溫度 (°C)
CBL-A1418-S1004-109A	12/24	4	1000	50000	2700/3000/4000/6500	100	>90	180	-20~+45
CBL-A1418-S1008-109A	12/24	8	1000	50000	2700/3000/4000/6500	100	>90	180	-20~+45
CBL-A1418-S1205-109A	12/24	5	1200	50000	2700/3000/4000/6500	100	>90	180	-20~+45
CBL-A1418-S1210-109A	12/24	10	1200	50000	2700/3000/4000/6500	100	>90	180	-20~+45

- Light efficiency (lm/W),Power (W),Color Rendering Index (CRI), Length Can be customized according to customer needs
- Our Standard Power factor (PF) > 0.9 and Total harmonic index THD < 15%, According to customer requirements can produce a lower THD < 10%
- This type of certification is issued by a government-approved laboratory for Safety certification, Fire testing, Restriction of Hazardous Substances(RoHS), Photobiological safety of lamps and lamp systems.(an Exemption Group) and other test certifications to ensure product quality

- 光效 (lm/W)、功率 (W)、顯色指數 (CRI)、長度,可根據客戶需求定制
- 此型號標準之功率因素 (PF)>0.9,總諧波指數THD<15%,可按客戶需要生產低總諧波指數<10%
- 此型號認證由可實驗室發出之安全認證消防測試,環保物料 (RoHS),光生物安全為Exemption Group及其它測試,保證客戶使用更安心滿意

Aluminum LED Strip

Series Type: A1713



Flick Free
(無閃頻)
保護視力

Features 產品特點 >>

- PC cover : milky
- Size: 17mm (W) x 13mm (H)
- SPM Design – power circuit protection to cut off individual LEDs when mal-functioned
- Aluminum to maximize heat dissipation
- Installation in serial for seamless lighting output
- Uniform light emission without LED spot
- Application: Kitchen cabinet, Bathroom cabinet ,Closet, Show cabinet, Retail shop,etc



- PC蓋:乳白色或透明
- 尺寸:17毫米(寬)X13毫米(高)
- 使用SPM設計-電源電路保護,在故障時切斷單個LED
- 採用鋁框架使散熱最大化
- 串聯安裝以實現無縫照明輸出
- 發光均勻,無LED光點
- 應用:廚櫃、浴室櫃、壁櫥、展示櫃、零售店等

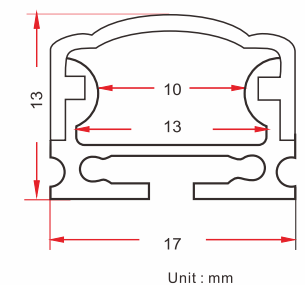

Specification 產品規格 >>

Model 型號	DC Voltage 電壓 (V)	Wattage 功率 (W)	Length 長度 (mm)	Lamp Life 光度壽命 (Hrs)	Colour Temp 色溫 (K)	Lumen Output 輸出流明 (Lm/W)	Color Rendering 顯色度 (CRI)	Beam Angle 光速角度 (°)	Operating Temperature 工作溫度 (°C)
CBL-A1713-S1004-108A	12/24	4	1000	50000	2700/3000/4000/6500	100	>90	120	-20~+45
CBL-A1713-S1008-109A	12/24	8	1000	50000	2700/3000/4000/6500	100	>90	120	-20~+45
CBL-A1713-S1205-109A	12/24	5	1200	50000	2700/3000/4000/6500	100	>90	120	-20~+45
CBL-A1713-S1210-109A	12/24	10	1200	50000	2700/3000/4000/6500	100	>90	120	-20~+45

- Light efficiency (lm/W),Power (W),Color Rendering Index (CRI), Length Can be customized according to customer needs
- Our Standard Power factor (PF) > 0.9 and Total harmonic index THD < 15%, According to customer requirements can produce a lower THD < 10%
- This type of certification is issued by a government-approved laboratory for Safety certification, Fire testing, Restriction of Hazardous Substances(RoHS), Photobiological safety of lamps and lamp systems.(an Exemption Group) and other test certifications to ensure product quality

- 光效 (lm/W)、功率 (W)、顯色指數 (CRI)、長度,可根據客戶需求定制
- 此型號標準之功率因素 (PF)>0.9,總諧波指數THD<15%,可按客戶需要生產低總諧波指數<10%
- 此型號認證由可實驗室發出之安全認證消防測試,環保物料 (RoHS),光生物安全為Exemption Group及其它測試,保證客戶使用更安心滿意

Aluminum LED Strip

Series Type: A2008



Flick Free
(無閃頻)
保護視力

Features 產品特點 >>

- PC cover : milky
- Size: 19.8mm (W) x 7.95 mm (H)
- SPM Design – power circuit protection to cut off individual LEDs when mal-functioned
- Aluminum to maximize heat dissipation
- Installation in serial for seamless lighting output
- Uniform light emission without LED spot
- Application: Kitchen cabinet, Bathroom cabinet ,Closet, Show cabinet, Retail shop,etc



- PC蓋: 乳白色
- 尺寸: 19.8毫米(寬)X7.95毫米(高)
- 使用SPM設計-電源電路保護, 在故障時切斷單個LED
- 採用鋁框架使散熱最大化
- 串聯安裝以實現無縫照明輸出
- 發光均勻,無LED光點
- 應用: 廚櫃、浴室櫃、壁櫥、展示櫃、零售店等

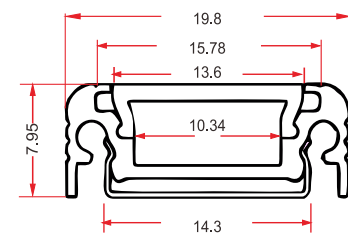

Unit : mm

Specification 產品規格 >>

Model 型號	DC Voltage 電壓 (V)	Wattage 功率 (W)	Length 長度 (mm)	Lamp Life 光度壽命 (Hrs)	Colour Temp 色溫 (K)	Lumen Output 輸出流明 (Lm/W)	Color Rendering 顯色度 (CRI)	Beam Angle 光速角度 (°)	Operating Temperature 工作溫度 (°C)
CBL-A2008-S1004-109A	12/24	4	1000	50000	2700/3000/4000/6500	100	>90	120	-20~+45
CBL-A2008-S1008-109A	12/24	8	1000	50000	2700/3000/4000/6500	100	>90	120	-20~+45
CBL-A2008-S1205-109A	12/24	5	1200	50000	2700/3000/4000/6500	100	>90	120	-20~+45
CBL-A2008-S1210-109A	12/24	10	1200	50000	2700/3000/4000/6500	100	>90	120	-20~+45

- Light efficiency (lm/W),Power (W),Color Rendering Index (CRI), Length Can be customized according to customer needs
- Our Standard Power factor (PF) > 0.9 and Total harmonic index THD < 15%, According to customer requirements can produce a lower THD < 10%
- This type of certification is issued by a government-approved laboratory for Safety certification, Fire testing, Restriction of Hazardous Substances(RoHS), Photobiological safety of lamps and lamp systems.(an Exemption Group) and other test certifications to ensure product quality

- 光效 (lm/W)、功率 (W)、顯色指數 (CRI)、長度, 可根據客戶需求定制
- 此型號標準之功率因素 (PF) > 0.9, 總諧波指數 THD < 15%, 可按客戶需要生產低總諧波指數 < 10%
- 此型號認證由可實驗室發出之安全認證消防測試, 環保物料 (RoHS), 光生物安全為 Exemption Group 及其它測試, 保證客戶使用更安心滿意

Aluminum LED Strip

Series Type: A2021



Flick Free
(無閃頻)
保護視力

Features 產品特點 >>

- PC cover : milky
- Size: 20mm (W) x 21mm (H)
- SPM Design – power circuit protection to cut off individual LEDs when mal-functioned
- Aluminum to maximize heat dissipation
- Installation in serial for seamless lighting output
- Uniform light emission without LED spot
- Application: Kitchen cabinet, Bathroom cabinet ,Closet, Show cabinet, Retail shop,etc



- PC蓋: 乳白色或透明
- 尺寸: 20毫米(寬)X21毫米(高)
- 使用SPM設計-電源電路保護, 在故障時切斷單個LED
- 採用鋁框架使散熱最大化
- 串聯安裝以實現無縫照明輸出
- 發光均勻,無LED光點
- 應用: 廚櫃、浴室櫃、壁櫥、展示櫃、零售店等

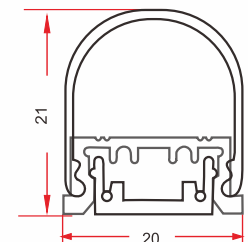

Unit : mm

Specification 產品規格 >>

Model 型號	DC Voltage 電壓 (V)	Wattage 功率 (W)	Length 長度 (mm)	Lamp Life 光度壽命 (Hrs)	Colour Temp 色溫 (K)	Lumen Output 輸出流明 (Lm/W)	Color Rendering 顯色度 (CRI)	Beam Angle 光速角度 (°)	Operating Temperature 工作溫度 (°C)
CBL-A2021-S1004-109A	12/24	4	1000	50000	2700/3000/4000/6500	100	>90	270	-20~+45
CBL-A2021-S1008-109A	12/24	8	1000	50000	2700/3000/4000/6500	100	>90	270	-20~+45
CBL-A2021-S1205-109A	12/24	5	1200	50000	2700/3000/4000/6500	100	>90	270	-20~+45
CBL-A2021-S1210-109A	12/24	10	1200	50000	2700/3000/4000/6500	100	>90	270	-20~+45

- Light efficiency (lm/W),Power (W),Color Rendering Index (CRI), Length Can be customized according to customer needs
- Our Standard Power factor (PF) > 0.9 and Total harmonic index THD < 15%, According to customer requirements can produce a lower THD < 10%
- This type of certification is issued by a government-approved laboratory for Safety certification, Fire testing, Restriction of Hazardous Substances(RoHS), Photobiological safety of lamps and lamp systems.(an Exemption Group) and other test certifications to ensure product quality

- 光效 (lm/W)、功率 (W)、顯色指數 (CRI)、長度, 可根據客戶需求定制
- 此型號標準之功率因素 (PF) > 0.9, 總諧波指數 THD < 15%, 可按客戶需要生產低總諧波指數 < 10%
- 此型號認證由可實驗室發出之安全認證消防測試, 環保物料 (RoHS), 光生物安全為 Exemption Group 及其它測試, 保證客戶使用更安心滿意

Aluminum LED Strip

Series Type: A1010-S



Flick Free
(無閃頻)
保護視力

Features 產品特點 >>

- PC cover : milky
- Size: 10mm (W) x10mm (H)
- LED Cabinet Light Strip & Remote sensing switch
- Aluminum to maximize heat dissipation
- Exceptional even Illumination (LED spot not seen)
- Ideal for both direct or indirect light effect
- SPM Design - power circuit protection to cut off individual LEDs when mal-funcioned
- Infrared sensor to detect hand movement at 8cm distance
- Application: Kitchen cabinet, Bathroom cabinet ,Closet, Show cabinet, Retail shop,etc



- PC蓋:乳白色
- 尺寸:10mm(寬)x10mm(高)
- LED機櫃燈帶和遙感開關
- 鋁制,最大限度地散熱
- 卓越的均勻照明(看不到LED斑點)
- 直接或間接光效果的理想選擇
- SPM設計-電源電路保護,在出現故障時切斷單個LED
- 紅外感測器可檢測8cm距離處的手部運動
- 應用:廚櫃、浴室櫃、壁櫥、展示櫃、零售店等

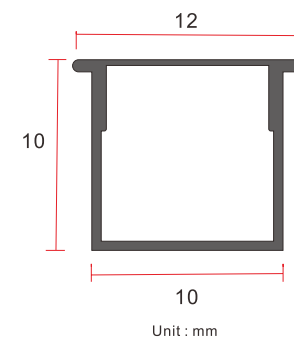

Specification 產品規格 >>

Model 型號	DC Voltage 電壓	Wattage 功率	Length 長度	Lamp Life 光度壽命	Colour Temp 色溫	Lumen Output 輸出流明	Color Rendering 顯色度	Beam Angle 光速角度	Operating Temperature 工作溫度
	(V)	(W)	(mm)	(Hrs)	(K)	(Lm/W)	(CRI)	(°)	(°C)
CBL-A1010-S	Dc24	8	1000	30000	3000/4000/6000	100	≥90	120	-20~+45

- Light efficiency (lm/W),Power (W),Color Rendering Index (CRI), Length Can be customized according to customer needs
- Our Standard Power factor (PF) > 0.9 and Total harmonic index THD < 15%, According to customer requirements can produce a lower THD< 10%
- This type of certification is issued by a government-approved laboratory for Safety certification, Fire testing, Restriction of Hazardous Substances(RoHS), Photobiological safety of lamps and lamp systems.(an Exemption Group) and other test certifications to ensure product quality

- 光效(lm/W)、功率(W)、顯色指數(CRI)、長度,可根據客戶需求定制
- 此型號標準之功率因素(PF)>0.9,總諧波指數THD<15%,可按客戶需要生產低總諧波指數<10%
- 此型號認證由可實驗室發出之安全認證消防測試,環保物料(RoHS),光生物安全為Exemption Group及其它測試,保證客戶使用更安心滿意

Aluminum LED Strip

Series Type:C2310L



Flick Free
(無閃頻)
保護視力

Features 產品特點 >>

- Material:Al6063 Aluminum
- Size: 23mm (width) X10mm (height)
- LED cold light source, pure light color, very good display effect
- High light transmission, non-glare, natural light color, uniform light
- High thermal conductivity aluminum-based PCB board, low heat generation and good heat dissipation
- Suitable for cabinet, wardrobe, wine cabinet, display cabinet, lockers and other furniture lighting

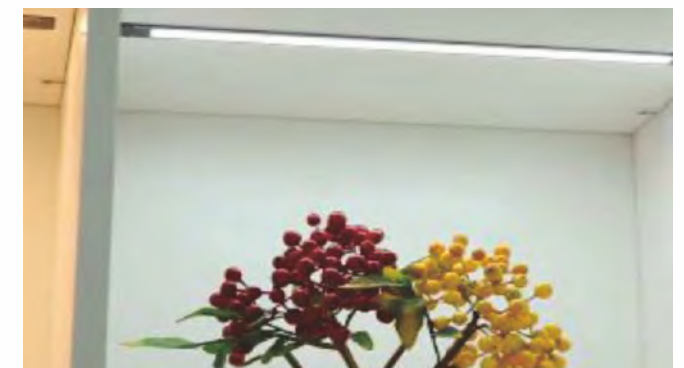

- 燈體材料:航空6063鋁
- 尺寸:23毫米(寬)X10毫米(高)
- LED冷光源,光色純正,非常好的展示效果
- 高透光,不刺眼,光色自然,光線均勻
- 採用高導熱鋁基PCB板,發熱量低,散熱好
- 適用於櫥櫃、衣櫃、酒櫃、展示櫃、儲物櫃等家具照明

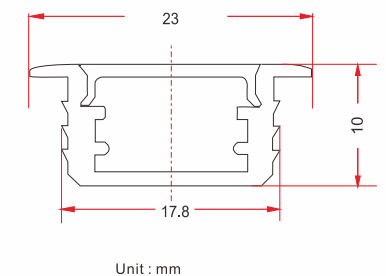

Specification 產品規格 >>

Model 型號	DC Voltage 電壓	Wattage 功率	Length 長度	Lamp Life 光度壽命	Colour Temp 色溫	Lumen Output 輸出流明	Color Rendering 顯色度	Beam Angle 光速角度	Operating Temperature 工作溫度
	(V)	(W)	(mm)	(Hrs)	(K)	(Lm/W)	(CRI)	(°)	(°C)
CBL-C2310L	12	12	1000	30000	3000/4000/6000	100	>90	120	-20~+45

- Light efficiency (lm/W),Power (W),Color Rendering Index (CRI), Length Can be customized according to customer needs
- Our Standard Power factor (PF) > 0.9 and Total harmonic index THD < 15%, According to customer requirements can produce a lower THD< 10%
- This type of certification is issued by a government-approved laboratory for Safety certification, Fire testing, Restriction of Hazardous Substances(RoHS), Photobiological safety of lamps and lamp systems.(an Exemption Group) and other test certifications to ensure product quality

- 光效(lm/W)、功率(W)、顯色指數(CRI)、長度,可根據客戶需求定制
- 此型號標準之功率因素(PF)>0.9,總諧波指數THD<15%,可按客戶需要生產低總諧波指數<10%
- 此型號認證由可實驗室發出之安全認證消防測試,環保物料(RoHS),光生物安全為Exemption Group及其它測試,保證客戶使用更安心滿意

Aluminum LED Strip

Series Type: C2408L



Features 產品特點 >>

- Material: Al6063 Aluminum
- Size: 24.8mm (width) X 8.5mm (height)
- Emitting arc lamp, a larger lighting surface
- Light body is smooth, high brightness, lightweight and thin
- UV resistance does not change yellow, high light transmission
- Suitable for lighting of cabinets, wardrobe, wine cabinets, display cabinets, lockers and other furniture



- 燈體材料：航空6063鋁
- 尺寸：24.8毫米(寬)X8.5毫米(高)
- 微弧型發光罩，亮化面更大
- 燈體光滑，亮度高，輕質超薄
- 抗UV紫外線不變黃，高透光
- 適用於櫥櫃，衣櫃，酒櫃，展示櫃，儲物櫃等家具照明

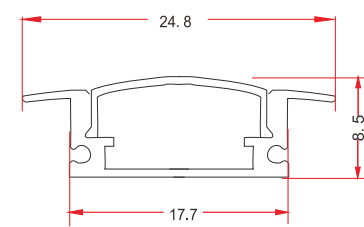

Unit : mm

Specification 產品規格 >>

Model 型號	DC Voltage 電壓	Wattage 功率	Length 長度	Lamp Life 光度壽命	Colour Temp 色溫	Lumen Output 輸出流明	Color Rendering 顯色度	Beam Angle 光速角度	Operating Temperature 工作溫度
	(V)	(W)	(mm)	(Hrs)	(K)	(Lm/W)	(CRI)	(°)	(°C)
CBL-C2408L	12	12	1000	30000	3000/4000/6000	100	>90	120	-20~+45

- Light efficiency (lm/W), Power (W), Color Rendering Index (CRI), Length Can be customized according to customer needs
- Our Standard Power factor (PF) > 0.9 and Total harmonic index THD < 15%, According to customer requirements can produce a lower THD < 10%
- This type of certification is issued by a government-approved laboratory for Safety certification, Fire testing, Restriction of Hazardous Substances (RoHS), Photobiological safety of lamps and lamp systems. (an Exemption Group) and other test certifications to ensure product quality

- 光效 (lm/W)、功率 (W)、顯色指數 (CRI)、長度，可根據客戶需求定制
- 此型號標準之功率因素 (PF) > 0.9，總諧波指數 THD < 15%，可按客戶需要生產低總諧波指數 < 10%
- 此型號認證由可實驗室發出之安全認證消防測試，環保物料 (RoHS)，光生物安全為 Exemption Group 及其它測試，保證客戶使用更安心滿意

Aluminum LED Strip

Series Type: C1515L



Features 產品特點 >>

- Material: Al6063 Aluminum
- Size: 23mm (width) X 10mm (height)
- A feast of light and vision, feel different beauty
- Easy installation, long life, no light spot design
- High thermal conductivity aluminum-based PCB board, low heat generation, fast heat dissipation
- Suitable for furniture lighting such as cabinets, wardrobes, wine cabinets, display cabinets, storage cabinets, etc.



- 燈體材料：航空6063鋁
- 尺寸：14.5毫米(寬)X14.5毫米(高)
- 燈光視覺盛宴，感受不一樣的美
- 易安裝，壽命長，無光點柔和設計
- 採用高導熱鋁基PCB板，發熱量低，散熱好
- 適用於櫥櫃，衣櫃，酒櫃，展示櫃，儲物櫃等家具照明

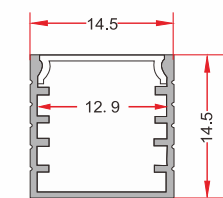

Unit : mm

Specification 產品規格 >>

Model 型號	DC Voltage 電壓	Wattage 功率	Length 長度	Lamp Life 光度壽命	Colour Temp 色溫	Lumen Output 輸出流明	Color Rendering 顯色度	Beam Angle 光速角度	Operating Temperature 工作溫度
	(V)	(W)	(mm)	(Hrs)	(K)	(Lm/W)	(CRI)	(°)	(°C)
CBL-C1515L	12	12	1000	30000	3000/4000/6000	100	>90	120	-20~+45

- Light efficiency (lm/W), Power (W), Color Rendering Index (CRI), Length Can be customized according to customer needs
- Our Standard Power factor (PF) > 0.9 and Total harmonic index THD < 15%, According to customer requirements can produce a lower THD < 10%
- This type of certification is issued by a government-approved laboratory for Safety certification, Fire testing, Restriction of Hazardous Substances (RoHS), Photobiological safety of lamps and lamp systems. (an Exemption Group) and other test certifications to ensure product quality

- 光效 (lm/W)、功率 (W)、顯色指數 (CRI)、長度，可根據客戶需求定制
- 此型號標準之功率因素 (PF) > 0.9，總諧波指數 THD < 15%，可按客戶需要生產低總諧波指數 < 10%
- 此型號認證由可實驗室發出之安全認證消防測試，環保物料 (RoHS)，光生物安全為 Exemption Group 及其它測試，保證客戶使用更安心滿意

Aluminum LED Strip

Series Type: C1808L



Flick Free
(無閃頻)
保護視力

Features 產品特點 >>

- Material: Al6063 Aluminum
- Size: 24.8mm (width) X 8.5mm (height)
- Necessary hand-scanning induction lamp under the cabinet and hanging cabinet.
- Resists UV rays, does not change yellow, high light transmission, cold resistance, high temperature resistance
- Easy to install, long life, ultra-thin lamp body, simple, smart and stylish
- Suitable for lighting of cabinets, wardrobe, wine cabinets, display cabinets, lockers and other furniture



- 燈體材料: 航空6063鋁
- 尺寸: 24.8毫米(寬)X8.5毫米(高)
- 櫥櫃吊櫃下必備手掃感應燈
- 抗UV紫外線不變黃, 高適光, 耐寒, 耐高溫
- 易安裝, 壽命長, 燈體超薄, 簡約, 智能, 時尚
- 適用於櫥櫃, 衣櫃, 酒櫃, 展示櫃, 儲物櫃等家具照明

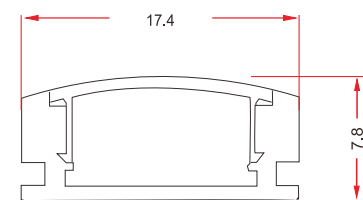

Unit : mm

Specification 產品規格 >>

Model 型號	DC Voltage 電壓	Wattage 功率	Length 長度	Lamp Life 光度壽命	Colour Temp 色溫	Lumen Output 輸出流明	Color Rendering 顯色度	Beam Angle 光速角度	Operating Temperature 工作溫度
	(V)	(W)	(mm)	(Hrs)	(K)	(Lm/W)	(CRI)	(°)	(°C)
CBL-C1808L	12	12	1000	30000	3000/4000/6000	100	>90	120	-20~+45

- Light efficiency (lm/W), Power (W), Color Rendering Index (CRI), Length Can be customized according to customer needs
- Our Standard Power factor (PF) > 0.9 and Total harmonic index THD < 15%, According to customer requirements can produce a lower THD < 10%
- This type of certification is issued by a government-approved laboratory for Safety certification, Fire testing, Restriction of Hazardous Substances (RoHS), Photobiological safety of lamps and lamp systems. (an Exemption Group) and other test certifications to ensure product quality

- 光效 (lm/W)、功率 (W)、顯色指數 (CRI)、長度, 可根據客戶需求定制
- 此型號標準之功率因素 (PF) > 0.9, 總諧波指數 THD < 15%, 可按客戶需要生產低總諧波指數 < 10%
- 此型號認證由實驗室發出之安全認證消防測試, 環保物料 (RoHS), 光生物安全為 Exemption Group 及其它測試, 保證客戶使用更安心滿意

Aluminum LED Strip

Series Type: C1712



Flick Free
(無閃頻)
保護視力

Features 產品特點 >>

- Material: Al6063 Aluminum
- Size: 17.5mm (width) X 11.8mm (height)
- Round plugs, flat plugs, multi-color aluminum, more perfect with furniture decoration
- Even light, no dark area, the first choice for cabinet lighting
- The surface of the whole lamp is anodized, which is more durable, and the lamp body is jagged, which is more secure
- Suitable for furniture lighting such as cabinets, wardrobes, wine cabinets, display cabinets, storage cabinets, etc

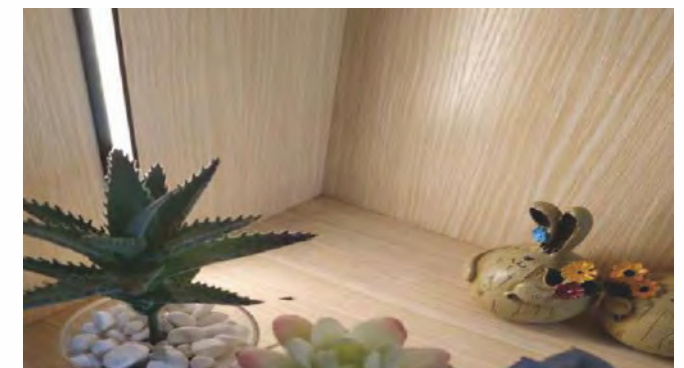

- 燈體材料: 航空6063鋁
- 尺寸: 17.5毫米(寬)X11.8毫米(高)
- 圓堵頭, 平堵頭, 多色鋁材, 更完美搭配家具裝飾
- 發光均勻, 無暗區, 櫃內燈光首選
- 整燈表面陽極氧化, 更耐用, 燈體呈鋸齒狀, 安裝更牢固
- 適用於櫥櫃, 衣櫃, 酒櫃, 展示櫃, 儲物櫃等家具照明

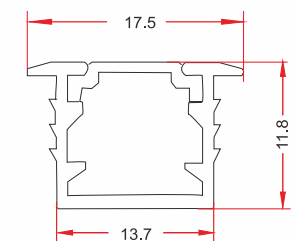

Unit : mm

Specification 產品規格 >>

Model 型號	DC Voltage 電壓	Wattage 功率	Length 長度	Lamp Life 光度壽命	Colour Temp 色溫	Lumen Output 輸出流明	Color Rendering 顯色度	Beam Angle 光速角度	Operating Temperature 工作溫度
	(V)	(W)	(mm)	(Hrs)	(K)	(Lm/W)	(CRI)	(°)	(°C)
CBL-C1712L	12	8	1000	30000	3000/4000/6000	100	>90	120	-20~+45

- Light efficiency (lm/W), Power (W), Color Rendering Index (CRI), Length Can be customized according to customer needs
- Our Standard Power factor (PF) > 0.9 and Total harmonic index THD < 15%, According to customer requirements can produce a lower THD < 10%
- This type of certification is issued by a government-approved laboratory for Safety certification, Fire testing, Restriction of Hazardous Substances (RoHS), Photobiological safety of lamps and lamp systems. (an Exemption Group) and other test certifications to ensure product quality

- 光效 (lm/W)、功率 (W)、顯色指數 (CRI)、長度, 可根據客戶需求定制
- 此型號標準之功率因素 (PF) > 0.9, 總諧波指數 THD < 15%, 可按客戶需要生產低總諧波指數 < 10%
- 此型號認證由實驗室發出之安全認證消防測試, 環保物料 (RoHS), 光生物安全為 Exemption Group 及其它測試, 保證客戶使用更安心滿意

LED Cabinet UVC Disinfection Light Strip

Series Type: UVC05

Features 產品特點 >>

- Microwave induction lamp strip with UVC disinfection, illumination + disinfection function
 - Automatic light turns on after detecting humans within 3M rang
 - Light turned off after the drawer or closet closed after 90s switch to UV disinfection mode, last for 30 / 90 / 180 mins (user selectable)
 - Switch to illumination mode whenever detecting human, so that the lighting lamp will be on when the person comes, and
 - the sterilization function will be started when the person walks
- It is suitable for furniture lighting such as cabinet, bathroom cabinet, shoe cabinet, wardrobe and drawer

- 帶有微波感應的UVC消毒燈條, 照明+消毒功能
- 探測到3米範圍內的人後, 自動燈亮開啟照明功能
- 抽屜或壁櫥關閉90秒後, 燈關閉切換至紫外線消毒模式, 持續30/90/180分鐘(殺菌時長自主可調)
- 只要檢測到人, 就切換到照明模式, 實現人來照明燈亮, 人走殺菌
- 適用於櫥櫃、浴室櫃、鞋櫃、衣櫃和抽屜等家具照明

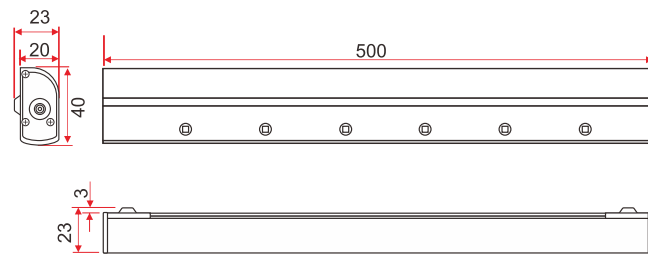
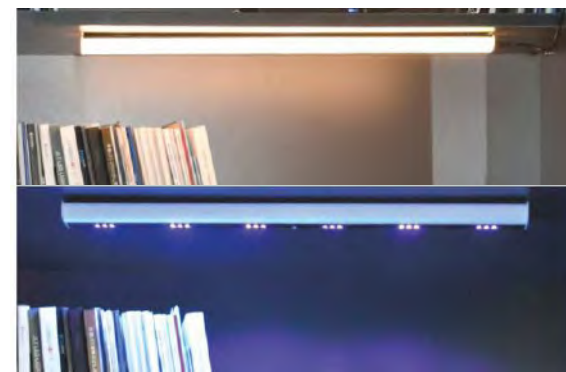
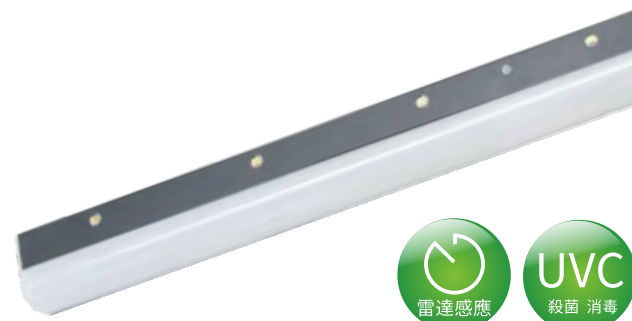

Unit : mm

Specification 產品規格 >>

Model 型號	DC Voltage 電壓	Wattage 照明功率	Wattage 殺毒功率	Length 長度	Lamp Life 光度壽命	Colour Temp 色溫	Lumen Output 輸出流明	Wave Length 波長	Beam Angle 光速角度	Operating Temperature 工作溫度
	(V)	(W)	(mW)	(mm)	(Hrs)	(K)	(Lm)	(nm)	(°)	(°C)
CBL-UVC05	24	4	60	500	30000	2700/3000/4000/6000	300	275	120	-20~+45

- Light efficiency (lm/W), Power (W), Color Rendering Index (CRI), Length Can be customized according to customer needs
- Our Standard Power factor (PF) > 0.9 and Total harmonic index THD < 15%, According to customer requirements can produce a lower THD < 10%
- This type of certification is issued by a government-approved laboratory for Safety certification, Fire testing, Restriction of Hazardous Substances (RoHS), Photobiological safety of lamps and lamp systems. (an Exemption Group) and other test certifications to ensure product quality

- 光效 (lm/W)、功率 (W)、顯色指數 (CRI)、長度, 可根據客戶需求定制
- 此型號標準之功率因素 (PF) > 0.9, 總諧波指數 THD < 15%, 可按客戶需要生產低總諧波指數 < 10%
- 此型號認證由可實驗室發出之安全認證消防測試, 環保物料 (RoHS), 光生物安全為 Exemption Group 及其它測試, 保證客戶使用更安心滿意



SOFT LIGHT STRIP

軟光條

5050 Light Belt Monochrome

Series Type: SLB-S



Flick Free
(無閃頻)
保護視力

Features 產品特點 >>

- High brightness patch 5050 LED is adopted as the light source with high brightness and wide Angle of view
- The base plate adopts double-sided imported calender copper FPC, which has good folding resistance and strong over-current capacity
- LED Nos: 60PCS/M
- Ultra-low power consumption, only 0.6 watts per unit
- Reasonable optical design, without flicker
- Suitable for indoor installation

- 採用高亮度貼片5050 LED作為高亮度寬視角光源
- 底板採用雙面進口壓延銅FPC, 抗折性好, 過電流能力強
- LED數量: 60PCS/M
- 超低功耗, 每臺僅0.6瓦
- 光學設計合理, 無光斑, 無頻閃
- 適用於室內安裝

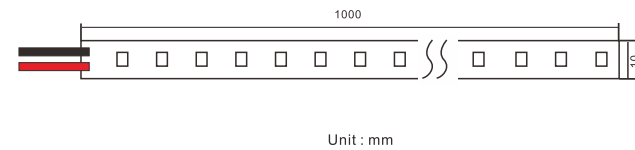
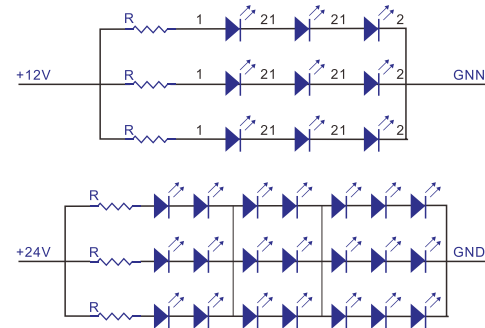
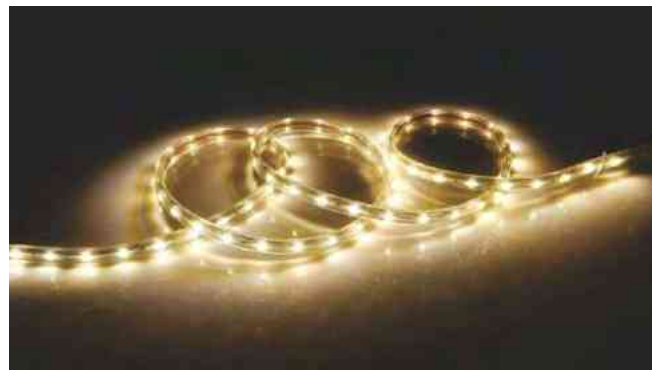

Specification 產品規格 >>

Model 型號	DC Voltage 電壓	Wattage 功率	Lamp Life 光度壽命	Colour Temp 色溫	Lumen Output 輸出流明	Color Rendering 顯色度	Length Per Roll 每卷長度	Size 尺寸
	(V)	(W/M)	(Hrs)	(K)	(Lm/W)	(CRI)	(M)	(mm)
SLB-S5050	12~24	14	50000	3000	80	>80	5	10*6

- Light efficiency (lm/W), Power (W), Color Rendering Index (CRI), Length Can be customized according to customer needs
- Our Standard Power factor (PF) > 0.9 and Total harmonic index THD < 15%. According to customer requirements can produce a lower THD < 10%
- This type of certification is issued by a government-approved laboratory for Safety certification, Fire testing, Restriction of Hazardous Substances (RoHS), Photobiological safety of lamps and lamp systems. (an Exemption Group) and other test certifications to ensure product quality

- 光效 (lm/W)、功率 (W)、顯色指數 (CRI)、長度, 可根據客戶需求定制
- 此型號標準之功率因素 (PF) > 0.9, 總諧波指數 THD < 15%, 可按客戶需要生產低總諧波指數 < 10%
- 此型號認證由可實驗室發出之安全認證消防測試, 環保物料 (RoHS), 光生物安全為 Exemption Group 及其它測試, 保證客戶使用更安心滿意

Glue Waterproof

Series Type: SLB-IP



Flick Free
(無閃頻)
保護視力

Features 產品特點 >>

- High brightness patch 2835 LED is adopted as the light source with high brightness and wide Angle of view
- The base plate adopts double-sided imported calender copper PVC
- LED Nos: 120PCS/M
- Beam angle: 120°
- Ultra-low power consumption, only 0.6 watts per unit
- Reasonable optical design, without flicker
- Good waterproof, suitable for indoor and outdoor installation

- 採用高亮度貼片2835 LED作為高亮度寬視角光源
- 底板採用雙面進口壓延銅PVC
- LED數量: 120PCS / M
- 光束角度120度
- 超低功耗, 每臺僅0.6瓦
- 光學設計合理, 無光斑, 無頻閃
- 防水性好, 適用於室內和室外安裝

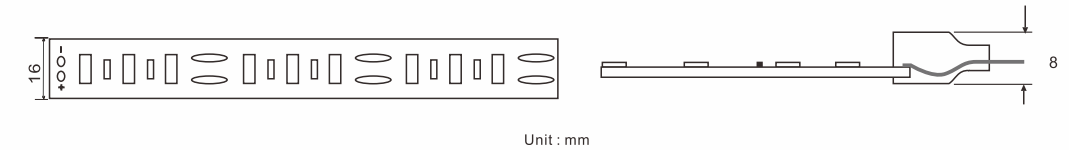

Specification 產品規格 >>

Model 型號	DC Voltage 電壓	Wattage 功率	Lamp Life 光度壽命	Colour Temp 色溫	Lumen Output 輸出流明	Color Rendering 顯色度	Length Per Roll 每卷長度	Size 尺寸
	(V)	(W/M)	(Hrs)	(K)	(Lm/W)	(CRI)	(M)	(mm)
SLB-IP2835	12	14	50000	3000/4000/6500	100	>80	5	16*8

- Light efficiency (lm/W), Power (W), Color Rendering Index (CRI), Length Can be customized according to customer needs
- Our Standard Power factor (PF) > 0.9 and Total harmonic index THD < 15%. According to customer requirements can produce a lower THD < 10%
- This type of certification is issued by a government-approved laboratory for Safety certification, Fire testing, Restriction of Hazardous Substances (RoHS), Photobiological safety of lamps and lamp systems. (an Exemption Group) and other test certifications to ensure product quality

- 光效 (lm/W)、功率 (W)、顯色指數 (CRI)、長度, 可根據客戶需求定制
- 此型號標準之功率因素 (PF) > 0.9, 總諧波指數 THD < 15%, 可按客戶需要生產低總諧波指數 < 10%
- 此型號認證由可實驗室發出之安全認證消防測試, 環保物料 (RoHS), 光生物安全為 Exemption Group 及其它測試, 保證客戶使用更安心滿意

RGB Waterproofing

Series Type: SLB-RGB-IP

Features 產品特點 >>

- High brightness patch 5050 LED is adopted as the light source with high brightness and wide Angle of view
 - The base plate adopts double-sided imported calender copper PVC, very good resistance
 - LED Nos: 60PCS/M
 - Beam angle:120°
 - Ultra-low power consumption, only 0.6 watts per unit
 - Reasonable optical design, without flicker
 - Easy installation with aluminium trough
 - Good waterproof, suitable for indoor and outdoor installation
- 採用高亮度貼片5050LED作為高亮度寬視角光源
 - 底板採用雙面進口壓PVC,耐用非常好
 - LED數量: 60PCS/M
 - 光束角度: 120°
 - 超低功耗, 每臺僅0.6瓦
 - 光學設計合理, 無光斑, 無頻閃
 - 鋁槽安裝方便
 - 防水性好, 適用於室內和室外安裝



Flick Free
(無閃頻)
保護視力

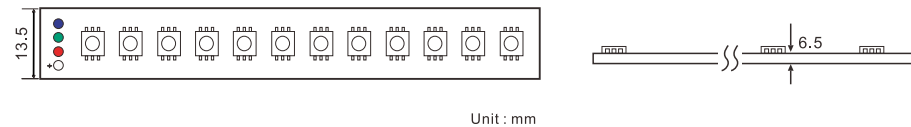

Specification 產品規格 >>

Model 型號	Voltage 電壓	Wattage 功率	Lamp Life 光度壽命	Colour Temp 色溫	Lumen Output 輸出流明	Color Rendering 顯色度	Length Per Roll 每卷長度	Size 尺寸
	(V)	(W/M)	(Hrs)	(K)	(Lm/W)	(CRI)	(M)	(mm)
SLB-RGB-IP5050	220~240	13.5	50000	RGB	100	>80	5	13.5*6.5

- Light efficiency (lm/W), Power (W), Color Rendering Index (CRI), Length Can be customized according to customer needs
 - Our Standard Power factor (PF) > 0.9 and Total harmonic index THD < 15%, According to customer requirements can produce a lower THD < 10%
 - This type of certification is issued by a government-approved laboratory for Safety certification, Fire testing, Restriction of Hazardous Substances (RoHS), Photobiological safety of lamps and lamp systems. (an Exemption Group) and other test certifications to ensure product quality
- 光效 (lm/W)、功率 (W)、顯色指數 (CRI)、長度, 可根據客戶需求定制
 - 此型號標準之功率因素 (PF) > 0.9, 總諧波指數 THD < 15%, 可按客戶需要生產低總諧波指數 < 10%
 - 此型號認證由可實驗室發出之安全認證消防測試, 環保物料 (RoHS), 光生物安全為 Exemption Group 及其它測試, 保證客戶使用更安心滿意

Monochrome/double Row

Series Type: SLB-SD

Features 產品特點 >>

- High brightness patch 2835 LED is adopted as the light source with high brightness and wide Angle of view
 - The base plate adopts double-sided imported calender copper FPC, which has good folding resistance and strong over-current capacity
 - LED Nos: 120PCS/M
 - Beam angle:120°
 - Ultra-low power consumption, only 0.6 watts per unit
 - Reasonable optical design, without flicker
 - Suitable for indoor installation
- 採用高亮度貼片2835LED作為高亮度寬視角光源
 - 底板採用雙面進口壓延銅FPC, 抗折性好, 過電流能力强
 - LED數量: 120PCS / M
 - 光束角度120度
 - 超低功耗, 每臺僅0.6瓦
 - 光學設計合理, 無光斑, 無頻閃
 - 適用於室內安裝



Flick Free
(無閃頻)
保護視力

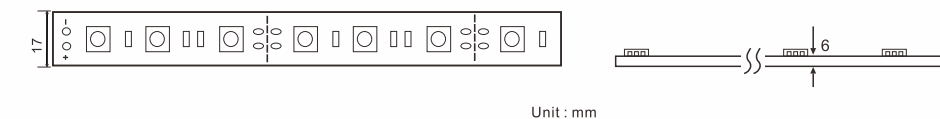

Specification 產品規格 >>

Model 型號	Voltage 電壓	Wattage 功率	Lamp Life 光度壽命	Colour Temp 色溫	Lumen Output 輸出流明	Color Rendering 顯色度	Length Per Roll 每卷長度	Size 尺寸
	(V)	(W/M)	(Hrs)	(K)	(Lm/W)	(CRI)	(M)	(mm)
SLB-SD5630	220~240	14.4	50000	2700-6500	100	>80	5	17*6

- Light efficiency (lm/W), Power (W), Color Rendering Index (CRI), Length Can be customized according to customer needs
 - Our Standard Power factor (PF) > 0.9 and Total harmonic index THD < 15%, According to customer requirements can produce a lower THD < 10%
 - This type of certification is issued by a government-approved laboratory for Safety certification, Fire testing, Restriction of Hazardous Substances (RoHS), Photobiological safety of lamps and lamp systems. (an Exemption Group) and other test certifications to ensure product quality
- 光效 (lm/W)、功率 (W)、顯色指數 (CRI)、長度, 可根據客戶需求定制
 - 此型號標準之功率因素 (PF) > 0.9, 總諧波指數 THD < 15%, 可按客戶需要生產低總諧波指數 < 10%
 - 此型號認證由可實驗室發出之安全認證消防測試, 環保物料 (RoHS), 光生物安全為 Exemption Group 及其它測試, 保證客戶使用更安心滿意

Double Color

Series Type: SLB-D-IP



Flick Free
(無閃頻)
保護視力

Features 產品特點 >>

- High brightness patch 2835 LED is adopted as the light source with high brightness and wide Angle of view
- The base plate adopts double-sided imported calender copper PVC, very good resistance
- LED Nos: 120PCS/M
- Beam angle:120°
- Ultra-low power consumption, only 0.6 watts per unit
- Reasonable optical design, without flicker
- Easy installation with aluminium trough
- Good waterproof, suitable for indoor and outdoor installation



- 採用高亮度贴片2835LED作為高亮度寬視角光源
- 底板採用雙面進口壓PVC,耐性非常好
- LED數量: 120PCS/M
- 光束角度: 120°
- 超低功耗,每臺僅0.6瓦
- 光學設計合理,無光斑,無頻閃
- 鋁槽安裝方便
- 防水性好,適用於室內和室外安裝

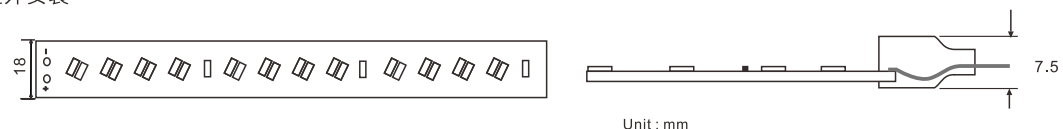

Specification 產品規格 >>

Model 型號	Voltage 電壓	Wattage 功率	Lamp Life 光度壽命	Colour Temp 色溫	Lumen Output 輸出流明	Color Rendering 顯色度	Length Per Roll 每卷長度	Size 尺寸
	(V)	(W/M)	(Hrs)	(K)	(Lm/W)	(CRI)	(M)	(mm)
SLB-D-IP5630	220~240	13.5	50000	2700~6500	100-140	>80	5	18*7.5

- Light efficiency (lm/W), Power (W), Color Rendering Index (CRI), Length Can be customized according to customer needs
- Our Standard Power factor (PF) > 0.9 and Total harmonic index THD < 15%, According to customer requirements can produce a lower THD < 10%
- This type of certification is issued by a government-approved laboratory for Safety certification, Fire testing, Restriction of Hazardous Substances (RoHS), Photobiological safety of lamps and lamp systems. (an Exemption Group) and other test certifications to ensure product quality

- 光效 (lm/W)、功率 (W)、顯色指數 (CRI)、長度, 可根據客戶需求定制
- 此型號標準之功率因素 (PF) > 0.9, 總諧波指數 THD < 15%, 可按客戶需要生產低總諧波指數 < 10%
- 此型號認證由可實驗室發出之安全認證消防測試, 環保物料 (RoHS), 光生物安全為 Exemption Group 及其它測試, 保證客戶使用更安心滿意



Transparent waterproof series

透明防水系列



IP65 Hollow Light Belt

Series Type: SLB-T-65

Features 產品特點 >>

- Silica gel material, very good resistance
- Light transmittance of more than 90%, high tensile strength, tensile rate of 500%
- High brightness patch 5050 LED is adopted as the light
- Hollow design, color temperature control within 3%
- Reasonable optical design, without flicker
- The luminous surface is arc-shaped, the luminous angle is good, and the plane illuminance curve is good
- Suitable for indoor or semi-outdoor trough

- 矽膠材質, 耐候性非常好
- 透光率90%以上, 抗拉强度高, 拉伸速率500%
- 採用高亮度貼片5050 LED作為光源
- 鏤空設計, 色溫控制3%以內
- 光學設計合理, 無光斑, 無頻閃
- 發光面弧形, 發光角度好, 平面照度曲線好
- 適用於室內或者半戶外

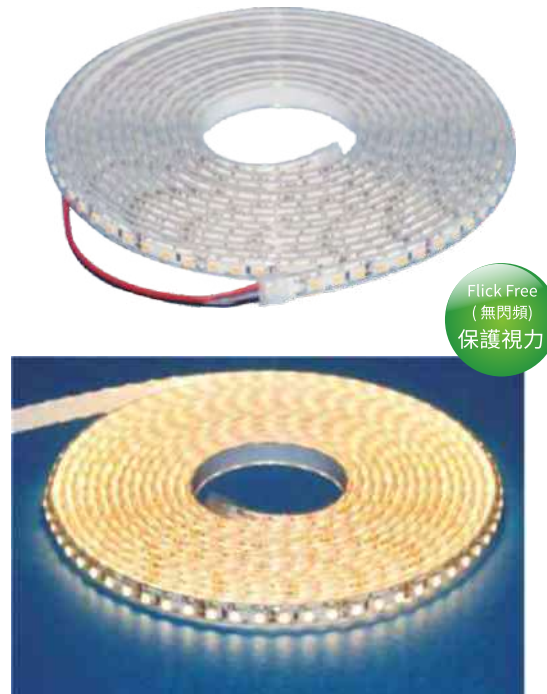

Flick Free
(無閃頻)
保護視力

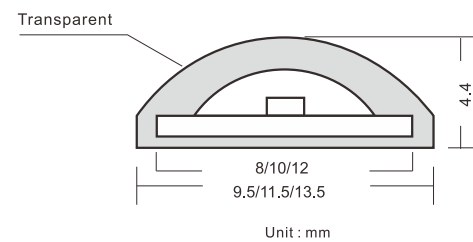

Specification 產品規格 >>

Model 型號	DC Voltage 電壓	Wattage 功率	Lamp Life 光度壽命	Colour Temp 色溫	Lumen Output 輸出流明	Total Lumen 總流明	Color Rendering 顯色度	Suitable Plate Width 適宜板寬	Size 尺寸
	(V)	(W/M)	(Hrs)	(K)	(Lm/W)	(Lm/M)	(CRI)	(mm)	(mm)
SLB-T1004-65	12/24	9.6/4.8	50000	3000	100	960 / 480	>80	8	9.5*4.4
SLB-T1204-65	12/24	9.6/4.8	50000	3000	100	960 / 480	>80	10	11.5*4.4
SLB-T1404-65	12/24	9.6/4.8	50000	3000	100	960 / 480	>80	12	13.5*4.4

- Light efficiency (lm/W), Power (W), Color Rendering Index (CRI), Length can be customized according to customer needs
- Our Standard Power factor (PF) > 0.9 and Total harmonic index THD < 15%. According to customer requirements can produce a lower THD < 10%
- This type of certification is issued by a government-approved laboratory for Safety certification, Fire testing, Restriction of Hazardous Substances (RoHS), Photobiological safety of lamps and lamp systems. (an Exemption Group) and other test certifications to ensure product quality

- 光效 (lm/W)、功率 (W)、顯色指數 (CRI), 長度可根據客戶需求定制
- 此型號標準之功率因素 (PF) > 0.9, 總諧波指數 THD < 15%, 可按客戶需要生產低總諧波指數 < 10%
- 此型號認證由可實驗室發出之安全認證消防測試, 環保物料 (RoHS), 光生物安全為 Exemption Group 及其它測試, 保證客戶使用更安心滿意

IP67 Hollow Light Belt

Series Type: SLB-T-67

Features 產品特點 >>

- Silica gel material, very good resistance
- Light transmittance of more than 90%, high tensile strength, tensile rate of 500%
- High brightness patch 5050 LED is adopted as the light
- Hollow design, better heat dissipation
- Reasonable optical design, without flicker
- The luminous surface is square, the luminous angle is good, and the plane illuminance curve is good
- Suitable for indoor or outdoor non-deep water

- 矽膠材質, 耐候性常好
- 透光率90%以上, 抗拉强度高, 拉伸速率500%
- 採用高亮度貼片5050 LED作為光源
- 鏤空設計, 散熱性好
- 光學設計合理, 無光斑, 無頻閃
- 發光面正面, 發光角度好, 平面照度曲線好
- 適用於室內或者室外非深水處



Flick Free
(無閃頻)
保護視力

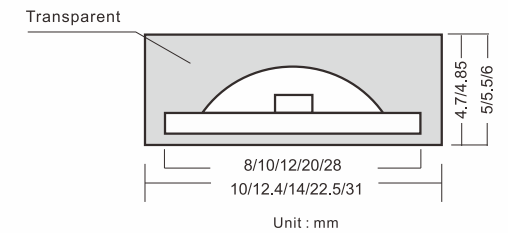

Specification 產品規格 >>

Model 型號	DC Voltage 電壓	Wattage 功率	Lamp Life 光度壽命	Colour Temp 色溫	Lumen Output 輸出流明	Total Lumen 總流明	Color Rendering 顯色度	Suitable Plate Width 適宜板寬	Size 尺寸
	(V)	(W/M)	(Hrs)	(K)	(Lm/W)	(Lm/M)	(CRI)	(mm)	(mm)
SLB-T1005-67	12/24	9.6/4.8	50000	3000	100	960 / 480	>80	8	10*4.7
SLB-T1205-67	12/24	9.6/4.8	50000	3000	100	960 / 480	>80	10	12*4.85
SLB-T1405-67	12/24	9.6/4.8	50000	3000	100	960 / 480	>80	12	14*5
SLB-T2206-67	12/24	9.6/4.8	50000	3000	100	960 / 480	>80	20	22*5.5
SLB-T3106-67	12/24	9.6/4.8	50000	3000	100	960 / 480	>80	28	31*6

- Light efficiency (lm/W), Power (W), Color Rendering Index (CRI), Length can be customized according to customer needs
- Our Standard Power factor (PF) > 0.9 and Total harmonic index THD < 15%. According to customer requirements can produce a lower THD < 10%
- This type of certification is issued by a government-approved laboratory for Safety certification, Fire testing, Restriction of Hazardous Substances (RoHS), Photobiological safety of lamps and lamp systems. (an Exemption Group) and other test certifications to ensure product quality

- 光效 (lm/W)、功率 (W)、顯色指數 (CRI), 長度可根據客戶需求定制
- 此型號標準之功率因素 (PF) > 0.9, 總諧波指數 THD < 15%, 可按客戶需要生產低總諧波指數 < 10%
- 此型號認證由可實驗室發出之安全認證消防測試, 環保物料 (RoHS), 光生物安全為 Exemption Group 及其它測試, 保證客戶使用更安心滿意

IP68 Solid Light Strip

Series Type: SLB-T-68

Features 產品特點 >>

- Silica gel material, very good resistance
- Light transmittance of more than 90%, high tensile strength, tensile rate of 500%
- High brightness patch 5050 LED is adopted as the light
- Extrusion solid design, plug molding integrated molding
- Reasonable optical design, without flicker
- The light-emitting surface is square, the luminous angle is good, and the plane illuminance curve is good
- Suitable for indoor or outdoor non-deep water

- 矽膠材質, 耐候性非常好
- 透光率90%以上, 抗拉强度高, 拉伸速率500%
- 採用高亮度貼片5050 LED作為光源
- 擠出實心設計, 堵頭模壓一體成型
- 光學設計合理, 無光斑, 無頻閃
- 發光面方形, 發光角度好, 平面照度曲線好
- 適用於室內或者室外非深水處

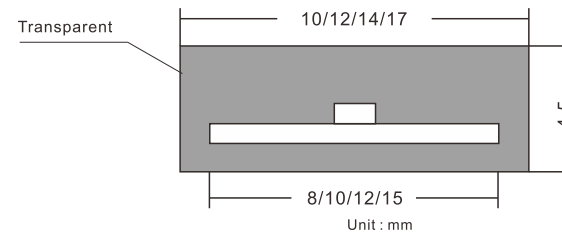

Specification 產品規格 >>

Model 型號	DC Voltage 電壓 (V)	Wattage 功率 (W/M)	Lamp Life 光度壽命 (Hrs)	Colour Temp 色溫 (K)	Lumen Output 輸出流明 (Lm/W)	Total Lumen 總流明 (Lm/M)	Color Rendering 顯色度 (CRI)	Suitable Plate Width 適宜板寬 (mm)	Size 尺寸 (mm)
SLB-T1004-68	12/24	9.6/4.8	50000	3000	100	960 / 480	>80	8	10*4.5
SLB-T1204-68	12/24	9.6/4.8	50000	3000	100	960 / 480	>80	10	12*4.5
SLB-T1404-68	12/24	9.6/4.8	50000	RGB	100	960 / 480	>80	12	14*4.5
SLB-T1704-68	12/24	9.6/4.8	50000	RGB	100	960 / 480	>80	15	17*4.5

- Light efficiency (lm/W), Power (W), Color Rendering Index (CRI), Length can be customized according to customer needs
- Our Standard Power factor (PF) > 0.9 and Total harmonic index THD < 15%. According to customer requirements can produce a lower THD < 10%
- This type of certification is issued by a government-approved laboratory for Safety certification, Fire testing, Restriction of Hazardous Substances (RoHS), Photobiological safety of lamps and lamp systems, (an Exemption Group) and other test certifications to ensure product quality

- 光效 (lm/W)、功率 (W)、顯色指數 (CRI), 長度可根據客戶需求定制
- 此型號標準之功率因素 (PF) > 0.9, 總諧波指數 THD < 15%, 可按客戶需要生產低總諧波指數 < 10%
- 此型號認證由可實驗室發出之安全認證消防測試, 環保物料 (RoHS), 光生物安全為 Exemption Group 及其它測試, 保證客戶使用更安心滿意

Neon Light STRIP

霓虹燈帶

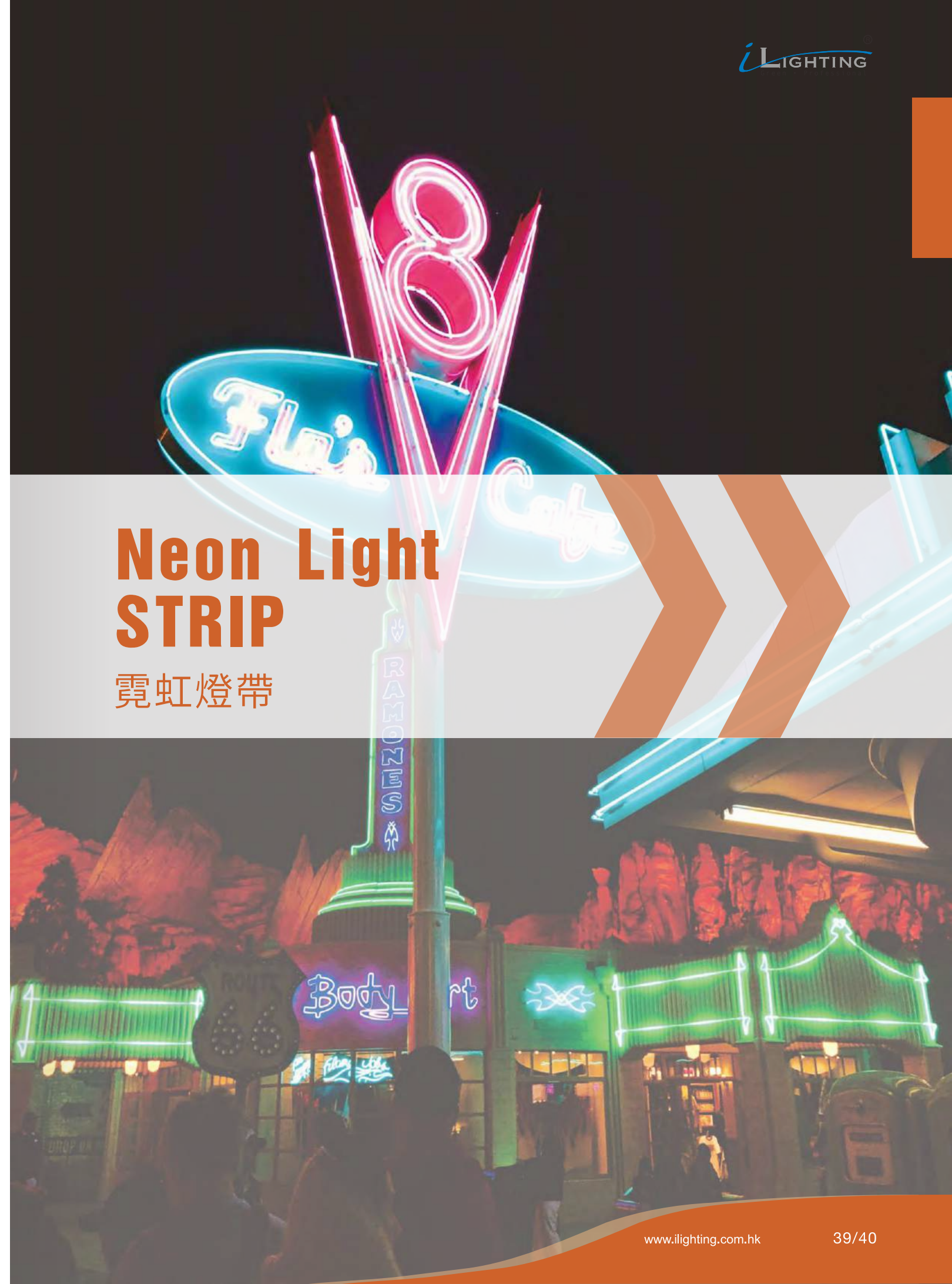

IP Series Neon Light

Series Type: SLB-NL-IP



Features 產品特點 >>

- High brightness patch 2835 LED is adopted as the light source with high brightness and wide Angle of view
- The base plate adopts double-sided imported calender copper PVC, very good resistance
- LED Nos: 120PCS/M
- Beam angle:120°
- Ultra-low power consumption, only 0.6 watts per unit
- Reasonable optical design, without flicker
- Easy installation with aluminium trough
- Good waterproof, suitable for indoor and outdoor installation



- 採用高亮度貼片2835LED作為高亮度寬視角光源
- 底板採用雙面進口壓PVC,耐候性非常好
- LED數量: 120PCS/M
- 光束角度: 120°
- 超低功耗, 每臺僅0.6瓦
- 光學設計合理, 無光斑, 無頻閃
- 鋁槽安裝方便
- 防水性好, 適用於室內和室外安裝

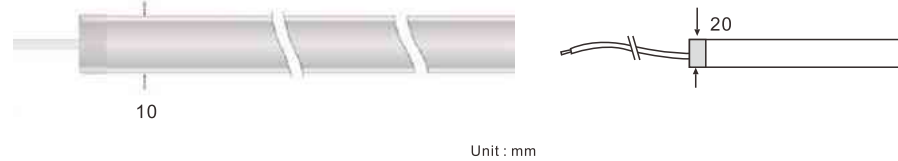

Specification 產品規格 >>

Model 型號	Voltage 電壓 (V)	Wattage 功率 (W)	Lamp Life 光度壽命 (Hrs)	Colour Temp 色溫 (K)	Lumen Output 輸出流明 (Lm/W)	Total Lumen 總流明 (Lm/M)	Color Rendering 顯色度 (CRI)	Waterproof Grade 防水等級 (IP)	Size 尺寸 (mm)
SLB-NL-IP2835	220~240	12	50000	2700-6500	100	1200	>80	65	1000*10*20

- Light efficiency (lm/W), Power (W), Color Rendering Index (CRI), Length Can be customized according to customer needs
- Our Standard Power factor (PF) > 0.9 and Total harmonic index THD < 15%, According to customer requirements can produce a lower THD < 10%
- This type of certification is issued by a government-approved laboratory for Safety certification, Fire testing, Restriction of Hazardous Substances (RoHS), Photobiological safety of lamps and lamp systems. (an Exemption Group) and other test certifications to ensure product quality

- 光效 (lm/W)、功率 (W)、顯色指數 (CRI)、長度, 可根據客戶需求定制
- 此型號標準之功率因素 (PF) > 0.9, 總諧波指數 THD < 15%, 可按客戶需要生產低總諧波指數 < 10%
- 此型號認證由可實驗室發出之安全認證消防測試, 環保物料 (RoHS), 光生物安全為 Exemption Group 及其它測試, 保證客戶使用更安心滿意

T5 Series Neon Light

Series Type: SLB-NL-T5

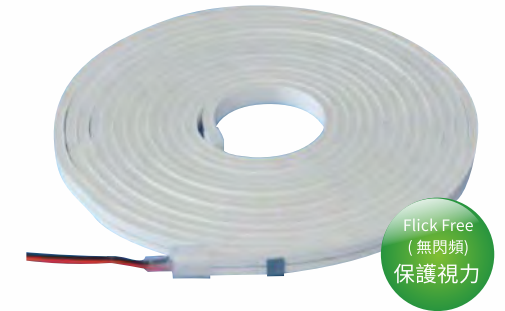

Features 產品特點 >>

- High brightness patch 2835 LED is adopted as the light source with high brightness and wide Angle of view
- Silicone material, very good weather resistance
- LED Nos: 120PCS/M, side glow
- Hollow design, good heat dissipation
- 5 * 10 three sided light blocking, light emitting flat head, 5*13 three sided light blocking, light emitting mushroom head, all can be cut arbitrarily
- The special design of the plug is convenient for shape docking, and there is no dark area in docking
- The light strip is very soft, convenient for packaging and any shape
- Suitable for indoor and outdoor

- 採用高亮度貼片2835LED作為高亮度寬視角光源
- 硅胶材質, 耐候性非常好
- LED數量: 120PCS/M, 側面發光
- 鏤空設計, 散熱性好
- 5*10三面擋光, 發光面平頭, 5*13三面擋光, 發光面蘑菇頭, 均可以任意裁剪
- 堵頭特殊設計, 方便造型對接, 對接無暗區
- 燈帶非常柔軟, 方便包裝以及任意造型
- 适用于室內室外

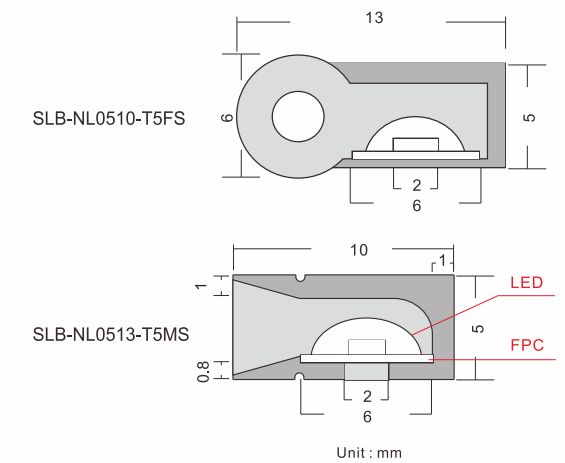

Specification 產品規格 >>

Model 型號	DC Voltage 電壓 (V)	Wattage 功率 (W/M)	Lamp Life 光度壽命 (Hrs)	Colour Temp 色溫 (K)	Lumen Output 輸出流明 (Lm/W)	Total Lumen 總流明 (Lm/M)	Color Rendering 顯色度 (CRI)	Waterproof Grade 防水等級 (IP)	Size 尺寸 (mm)
SLB-NL0510-T5FS	12/24	9.6/4.8	50000	3000	100	960 / 480	>80	IP67	5*10
SLB-NL0513-T5MS	12/24	9.6/4.8	50000	3000	100	960 / 480	>80	IP67	5*13

- Light efficiency (lm/W), Power (W), Color Rendering Index (CRI), Length Can be customized according to customer needs
- Our Standard Power factor (PF) > 0.9 and Total harmonic index THD < 15%, According to customer requirements can produce a lower THD < 10%
- This type of certification is issued by a government-approved laboratory for Safety certification, Fire testing, Restriction of Hazardous Substances (RoHS), Photobiological safety of lamps and lamp systems. (an Exemption Group) and other test certifications to ensure product quality

- 光效 (lm/W)、功率 (W)、顯色指數 (CRI)、長度, 可根據客戶需求定制
- 此型號標準之功率因素 (PF) > 0.9, 總諧波指數 THD < 15%, 可按客戶需要生產低總諧波指數 < 10%
- 此型號認證由可實驗室發出之安全認證消防測試, 環保物料 (RoHS), 光生物安全為 Exemption Group 及其它測試, 保證客戶使用更安心滿意

T6 Series Neon Light

Series Type: SLB-NL-T6

Features 產品特點 >>

- High brightness patch 2835 LED is adopted as the light source with high brightness and wide Angle of view
- Silicone material, very good weather resistance
- LED Nos: 120PCS/M, side glow
- Hollow design, good heat dissipation
- 6 * 12 three sided light blocking, light emitting flat head, 6*13 three sided light blocking, light emitting mushroom head, all can be cut arbitrarily
- The special design of the plug is convenient for shape docking, and there is no dark area in docking
- The light strip is very soft, convenient for packaging and any shape Suitable for indoor and outdoor

- 採用高亮度貼片2835LED作為高亮度寬視角光源
- LED數量：120PCS/M，側面發光
- 硅胶材質，耐候性非常好
- 鏤空設計，散熱性好
- 6*12三面擋光，發光面平頭，6*13三面擋光，發光面蘑菇頭，均可以任意裁剪
- 堵頭特殊設計，方便造型對接，對接無暗區
- 燈帶非常柔軟，方便包裝以及任意造型
- 适用于室內室外

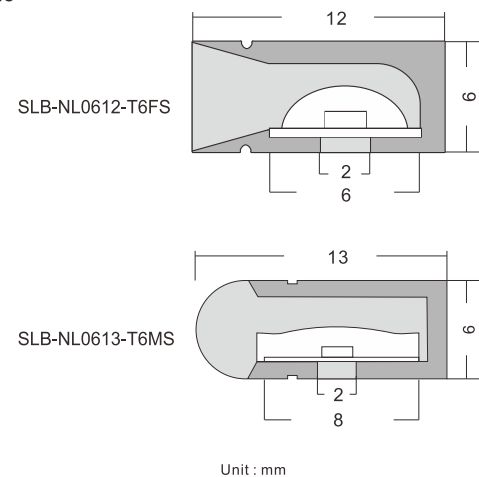
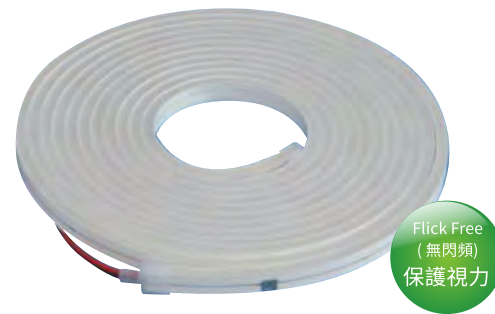

Specification 產品規格 >>

Model 型號	DC Voltage 電壓	Wattage 功率	Lamp Life 光度壽命	Colour Temp 色溫	Lumen Output 輸出流明	Total Lumen 總流明	Color Rendering 顯色度	Waterproof Grade 防水等級	Size 尺寸
	(V)	(W/M)	(Hrs)	(K)	(Lm/W)	(Lm/M)	(CRI)	(IP)	(mm)
SLB-NL0612-T6FS	12/24	9.6/4.8	50000	3000	100	960 / 480	>80	IP67	6*12
SLB-NL0613-T6MS	12/24	9.6/4.8	50000	3000	100	960 / 480	>80	IP67	6*13

- Light efficiency (lm/W), Power (W), Color Rendering Index (CRI), Length can be customized according to customer needs
- Our Standard Power factor (PF) > 0.9 and Total harmonic index THD < 15%, According to customer requirements can produce a lower THD < 10%
- This type of certification is issued by a government-approved laboratory for Safety certification, Fire testing, Restriction of Hazardous Substances (RoHS), Photobiological safety of lamps and lamp systems. (an Exemption Group) and other test certifications to ensure product quality
- 光效 (lm/W)、功率 (W)、顯色指數 (CRI)，長度可根據客戶需求定制
- 此型號標準之功率因素 (PF) > 0.9，總諧波指數 THD < 15%，可按客戶需要生產低總諧波指數 < 10%
- 此型號認證由可實驗室發出之安全認證消防測試，環保物料 (RoHS)，光生物安全為 Exemption Group 及其它測試，保證客戶使用更安心滿意

T7 Series Neon Light

Series Type: SLB-NL-T7

Features 產品特點 >>

- High brightness patch 2835 LED is adopted as the light source with high brightness and wide Angle of view
- Silicone material, very good weather resistance
- LED Nos: 120PCS/M, side glow
- Hollow design, good heat dissipation
- 7 * 14 three sided light blocking, illuminated mushroom head, can be cut freely
- The special design of the plug is convenient for shape docking, and there is no dark area in docking
- The light strip is very soft, convenient for packaging and any shape
- Suitable for indoor and outdoor

- 採用高亮度貼片2835LED作為高亮度寬視角光源
- 硅胶材質，耐候性非常好
- LED數量：120PCS/M，側面發光
- 鏤空設計，散熱性好
- 7*14三面擋光，發光面蘑菇頭，可以任意裁剪
- 堵頭特殊設計，方便造型對接，對接無暗區
- 燈帶非常柔軟，方便包裝以及任意造型
- 适用于室內室外

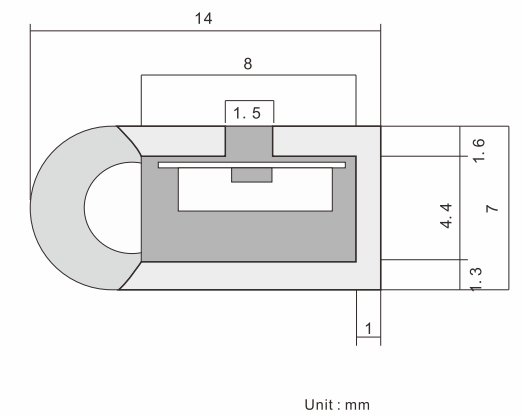

Specification 產品規格 >>

Model 型號	DC Voltage 電壓	Wattage 功率	Lamp Life 光度壽命	Colour Temp 色溫	Lumen Output 輸出流明	Total Lumen 總流明	Color Rendering 顯色度	Waterproof Grade 防水等級	Size 尺寸
	(V)	(W/M)	(Hrs)	(K)	(Lm/W)	(Lm/M)	(CRI)	(IP)	(mm)
SLB-NL0714-T7MS	12/24	9.6/4.8	50000	3000	100	960 / 480	>80	IP67	7*14

- Light efficiency (lm/W), Power (W), Color Rendering Index (CRI), Length can be customized according to customer needs
- Our Standard Power factor (PF) > 0.9 and Total harmonic index THD < 15%, According to customer requirements can produce a lower THD < 10%
- This type of certification is issued by a government-approved laboratory for Safety certification, Fire testing, Restriction of Hazardous Substances (RoHS), Photobiological safety of lamps and lamp systems. (an Exemption Group) and other test certifications to ensure product quality
- 光效 (lm/W)、功率 (W)、顯色指數 (CRI)，長度可根據客戶需求定制
- 此型號標準之功率因素 (PF) > 0.9，總諧波指數 THD < 15%，可按客戶需要生產低總諧波指數 < 10%
- 此型號認證由可實驗室發出之安全認證消防測試，環保物料 (RoHS)，光生物安全為 Exemption Group 及其它測試，保證客戶使用更安心滿意

T8 Series Neon Light

Series Type: SLB-NL-T8

Features 產品特點 >>

- High brightness patch 2835 LED is adopted as the light source with high brightness and wide Angle of view
- Silicone material, very good weather resistance
- LED Nos: 72PCS/M, side glow
- Hollow design, good heat dissipation
- 8*15 three sided light blocking, light emitting flat head, 8 * 16 three sided light blocking, light emitting mushroom head, all can be cut arbitrarily
- The special design of the plug is convenient for shape docking, and there is no dark area in docking
- The light strip is very soft, convenient for packaging and any shape
- Suitable for indoor and outdoor

- 採用高亮度貼片2835LED作為高亮度寬視角光源
- LED數量：72PCS/M，側面發光
- 矽膠材質，耐候性非常好
- 鏤空設計，散熱性好
- 8*15三面擋光，發光面平頭，8*16三面擋光，發光面蘑菇頭，均可以任意裁剪
- 堵頭特殊設計，方便造型對接，對接無暗區
- 燈帶非常柔軟，方便包裝以及任意造型
- 适用于室內室外

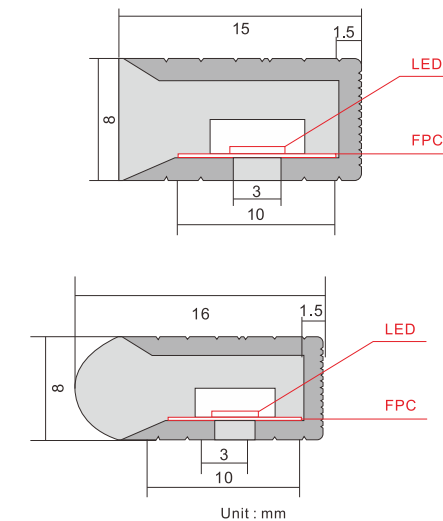

Specification 產品規格 >>

Model 型號	DC Voltage 電壓 (V)	Wattage 功率 (W/M)	Lamp Life 光度壽命 (Hrs)	Colour Temp 色溫 (K)	Lumen Output 輸出流明 (Lm/W)	Total Lumen 總流明 (Lm/M)	Color Rendering 顯色度 (CRI)	Waterproof Grade 防水等級 (IP)	Size 尺寸 (mm)
SLB-NL0815-T8FS	12/24	9.6/4.8	50000	3000	100	960 / 480	>80	IP67	8*15
SLB-NL0816-T8MS	12/24	9.6/4.8	50000	3000	100	960 / 480	>80	IP67	8*16

- Light efficiency (lm/W), Power (W), Color Rendering Index (CRI), Length can be customized according to customer needs
- Our Standard Power factor (PF) > 0.9 and Total harmonic index THD < 15%, According to customer requirements can produce a lower THD < 10%
- This type of certification is issued by a government-approved laboratory for Safety certification, Fire testing, Restriction of Hazardous Substances (RoHS), Photobiological safety of lamps and lamp systems. (an Exemption Group) and other test certifications to ensure product quality

- 光效 (lm/W)、功率 (W)、顯色指數 (CRI)，長度可根據客戶需求定制
- 此型號標準之功率因素 (PF) > 0.9，總諧波指數 THD < 15%，可按客戶需要生產低總諧波指數 < 10%
- 此型號認證由可實驗室發出之安全認證消防測試，環保物料 (RoHS)，光生物安全為 Exemption Group 及其它測試，保證客戶使用更安心滿意

High efficiency light strip

Series Type: SLB-NL-H

Features 產品特點 >>

- High brightness patch 2835 LED is adopted as the light source with high brightness and wide Angle of view
- Silicone material, very good weather resistance
- LED Nos: 120PCS/M
- Hollow design, good heat dissipation
- Can be arbitrarily cropped
- The special design of the plug is convenient for shape docking, and there is no dark area in docking
- The light strip is very soft, convenient for packaging and any shape
- Suitable for indoor and outdoor

- 採用高亮度貼片 2835LED 作為高亮度寬視角光源
- 矽膠材質，耐候性非常好
- LED數量：120PCS/M
- 鏤空設計，散熱性好
- 可以任意裁剪
- 堵頭特殊設計，方便造型對接，對接無暗區
- 燈帶非常柔軟，方便包裝以及任意造型
- 适用于室內室外

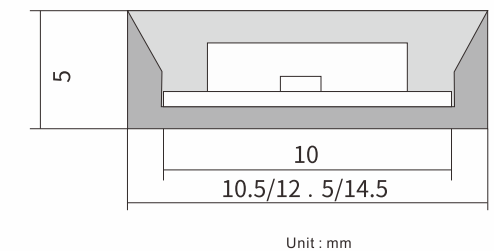
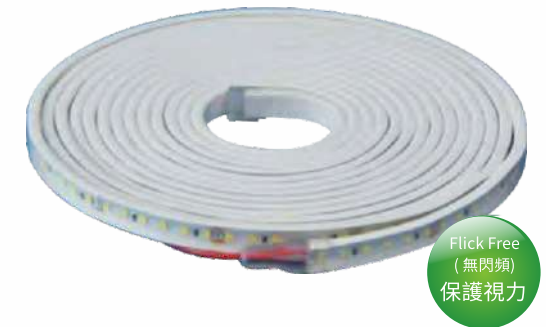

Specification 產品規格 >>

Model 型號	DC Voltage 電壓 (V)	Wattage 功率 (W/M)	Lamp Life 光度壽命 (Hrs)	Colour Temp 色溫 (K)	Lumen Output 輸出流明 (Lm/W)	Total Lumen 總流明 (Lm/M)	Color Rendering 顯色度 (CRI)	Waterproof Grade 防水等級 (IP)	Size 尺寸 (mm)
SLB-NL1105-HFF	12/24	9.6	50000	3000	100	960	>80	IP67	10.5*5
SLB-NL1305-HFF	12/24	9.6	50000	3000	100	960	>80	IP67	12.5*5
SLB-NL1505-HFF	12/24	9.6	50000	3000	100	960	>80	IP67	14.5*5

- Light efficiency (lm/W), Power (W), Color Rendering Index (CRI), Length can be customized according to customer needs
- Our Standard Power factor (PF) > 0.9 and Total harmonic index THD < 15%, According to customer requirements can produce a lower THD < 10%
- This type of certification is issued by a government-approved laboratory for Safety certification, Fire testing, Restriction of Hazardous Substances (RoHS), Photobiological safety of lamps and lamp systems. (an Exemption Group) and other test certifications to ensure product quality

- 光效 (lm/W)、功率 (W)、顯色指數 (CRI)，長度可根據客戶需求定制
- 此型號標準之功率因素 (PF) > 0.9，總諧波指數 THD < 15%，可按客戶需要生產低總諧波指數 < 10%
- 此型號認證由可實驗室發出之安全認證消防測試，環保物料 (RoHS)，光生物安全為 Exemption Group 及其它測試，保證客戶使用更安心滿意

T10 Series Neon Light

Series Type: SLB-NL-T10

Features 產品特點 >>

- High brightness patch 2835 LED is adopted as the light source with high brightness and wide Angle of view
- Silicone material, very good weather resistance
- LED Nos: 60PCS/M, side glow
- Hollow design, good heat dissipation
- Three sided light blocking, light emitting flat head, can be cut freely
- The special design of the plug is convenient for shape docking, and there is no dark area in docking
- The light strip is very soft, convenient for packaging and any shape
- Suitable for indoor and outdoor

- 採用高亮度貼片2835LED作為高亮度寬視角光源
- 硅胶材質, 耐候性非常好
- LED數量: 60PCS/M, 側面發光
- 鏤空設計, 散熱性好
- 三面擋光, 發光面平頭, 可以任意裁剪
- 堵頭特殊設計, 方便造型對接, 對接無暗區
- 燈帶非常柔軟, 方便包裝以及任意造型
- 适用于室內室外

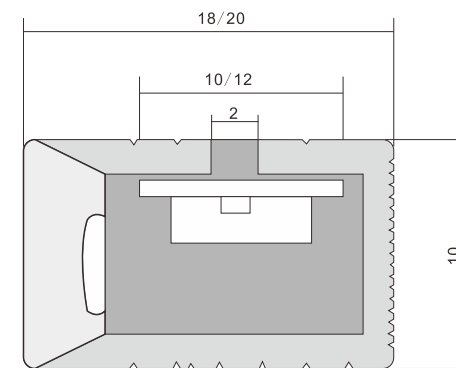
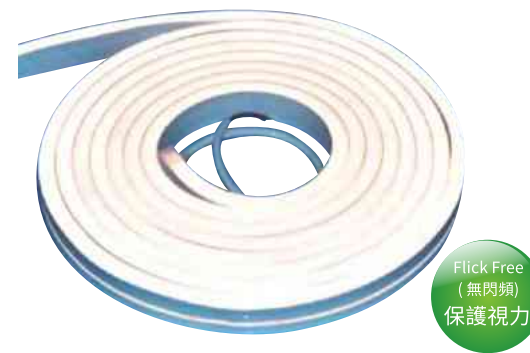

Unit : mm

Specification 產品規格 >>

Model 型號	DC Voltage 電壓 (V)	Wattage 功率 (W/M)	Lamp Life 光度壽命 (Hrs)	Colour Temp 色溫 (K)	Lumen Output 輸出流明 (Lm/W)	Total Lumen 總流明 (Lm/M)	Color Rendering 顯色度 (CRI)	Waterproof Grade 防水等級 (IP)	Size 尺寸 (mm)
SLB-NL1018-T10FS	12/24	9.6	50000	3000	100	960	>80	IP67	10*18
SLB-NL1020-T10FS	12/24	9.6	50000	3000	100	960	>80	IP67	10*20

- Light efficiency (lm/W), Power (W), Color Rendering Index (CRI), Length can be customized according to customer needs
- Our Standard Power factor (PF) > 0.9 and Total harmonic index THD < 15%, According to customer requirements can produce a lower THD < 10%
- This type of certification is issued by a government-approved laboratory for Safety certification, Fire testing, Restriction of Hazardous Substances (RoHS), Photobiological safety of lamps and lamp systems. (an Exemption Group) and other test certifications to ensure product quality
- 光效 (lm/W)、功率 (W)、顯色指數 (CRI), 長度可根據客戶需求定制
- 此型號標準之功率因素 (PF) > 0.9, 總諧波指數 THD < 15%, 可按客戶需要生產低總諧波指數 < 10%
- 此型號認證由可實驗室發出之安全認證消防測試, 環保物料 (RoHS), 光生物安全為 Exemption Group 及其它測試, 保證客戶使用更安心滿意

T10 Series Neon Light

Series Type: SLB-NL-T10

Features 產品特點 >>

- High brightness patch 2835 LED is adopted as the light source with high brightness and wide Angle of view
- Silicone material, very good weather resistance
- LED Nos: 60PCS/M, side glow
- Hollow design, good heat dissipation
- Three sided light blocking, glowing mushroom head. Can be cut freely
- The special design of the plug is convenient for shape docking, and there is no dark area in docking
- The light strip is very soft, convenient for packaging and any shape
- Suitable for indoor and outdoor

- 採用高亮度貼片2835LED作為高亮度寬視角光源
- 硅胶材質, 耐候性非常好
- LED數量: 60PCS/M, 側面發光
- 鏤空設計, 散熱性好
- 三面擋光, 發光面蘑菇頭, 可以任意裁剪
- 堵頭特殊設計, 方便造型對接, 對接無暗區
- 燈帶非常柔軟, 方便包裝以及任意造型
- 适用于室內室外

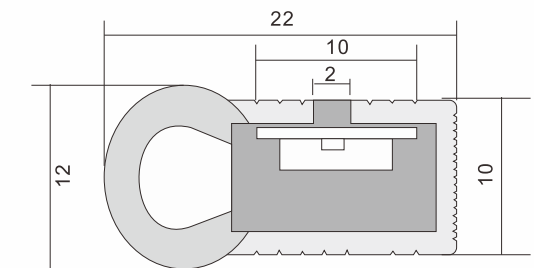

Unit : mm

Specification 產品規格 >>

Model 型號	DC Voltage 電壓 (V)	Wattage 功率 (W/M)	Lamp Life 光度壽命 (Hrs)	Colour Temp 色溫 (K)	Lumen Output 輸出流明 (Lm/W)	Total Lumen 總流明 (Lm/M)	Color Rendering 顯色度 (CRI)	Waterproof Grade 防水等級 (IP)	Size 尺寸 (mm)
SLB-NL1022-T10MS	12/24	9.6	50000	3000	100	960	>80	IP67	12*22

- Light efficiency (lm/W), Power (W), Color Rendering Index (CRI), Length can be customized according to customer needs
- Our Standard Power factor (PF) > 0.9 and Total harmonic index THD < 15%, According to customer requirements can produce a lower THD < 10%
- This type of certification is issued by a government-approved laboratory for Safety certification, Fire testing, Restriction of Hazardous Substances (RoHS), Photobiological safety of lamps and lamp systems. (an Exemption Group) and other test certifications to ensure product quality
- 光效 (lm/W)、功率 (W)、顯色指數 (CRI), 長度可根據客戶需求定制
- 此型號標準之功率因素 (PF) > 0.9, 總諧波指數 THD < 15%, 可按客戶需要生產低總諧波指數 < 10%
- 此型號認證由可實驗室發出之安全認證消防測試, 環保物料 (RoHS), 光生物安全為 Exemption Group 及其它測試, 保證客戶使用更安心滿意

T10 Series Neon Light

Series Type: SLB-NL-T10

Features 產品特點 >>

- High brightness patch 2835 LED is adopted as the light source with high brightness and wide Angle of view
- Silicone material, very good weather resistance
- LED Nos: 60PCS/M
- Hollow design, good heat dissipation
- Can be arbitrarily cropped
- The special design of the plug is convenient for shape docking, and there is no dark area in docking
- The light strip is very soft, convenient for packaging and any shape
- Suitable for indoor and outdoor

- 採用高亮度貼片2835LED作為高亮度寬視角光源
- 硅胶材質, 耐候性非常好
- LED數量: 60PCS/M
- 鏤空設計, 散熱性好
- 可以任意裁剪
- 堵頭特殊設計, 方便造型對接, 對接無暗區
- 燈帶非常柔軟, 方便包裝以及任意造型
- 适用于室內室外

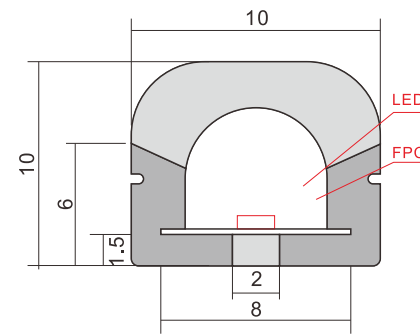
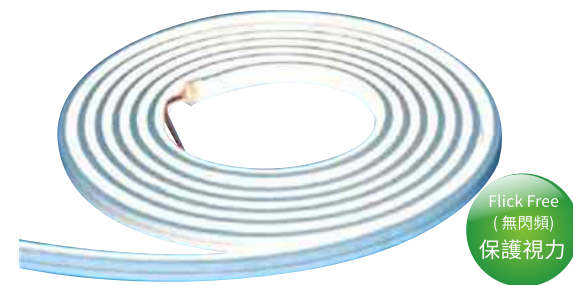

Unit : mm

Specification 產品規格 >>

Model 型號	DC Voltage 電壓	Wattage 功率	Lamp Life 光度壽命	Colour Temp 色溫	Lumen Output 輸出流明	Total Lumen 總流明	Color Rendering 顯色度	Waterproof Grade 防水等級	Size 尺寸
	(V)	(W/M)	(Hrs)	(K)	(Lm/W)	(Lm/M)	(CRI)	(IP)	(mm)
SLB-NL1010-T10FF	12/24	9.6	50000	3000	100	960	>80	IP67	10*10

- Light efficiency (lm/W), Power (W), Color Rendering Index (CRI), Length can be customized according to customer needs
- Our Standard Power factor (PF) > 0.9 and Total harmonic index THD < 15%, According to customer requirements can produce a lower THD < 10%
- This type of certification is issued by a government-approved laboratory for Safety certification, Fire testing, Restriction of Hazardous Substances (RoHS), Photobiological safety of lamps and lamp systems. (an Exemption Group) and other test certifications to ensure product quality

- 光效 (lm/W)、功率 (W)、顯色指數 (CRI), 長度可根據客戶需求定制
- 此型號標準之功率因素 (PF) > 0.9, 總諧波指數 THD < 15%, 可按客戶需要生產低總諧波指數 < 10%
- 此型號認證由可實驗室發出之安全認證消防測試, 環保物料 (RoHS), 光生物安全為 Exemption Group 及其它測試, 保證客戶使用更安心滿意

T12 Series Neon Light

Series Type: SLB-NL-T12

Features 產品特點 >>

- High brightness patch 2835 LED is adopted as the light source with high brightness and wide Angle of view
- Silicone material, very good weather resistance
- LED Nos: 120PCS/M, side glow
- Hollow design, good heat dissipation
- Three sided light blocking, glowing mushroom head. Can be cut freely
- The special design of the plug is convenient for shape docking, and there is no dark area in docking
- The light strip is very soft, convenient for packaging and any shape
- Suitable for indoor and outdoor

- 採用高亮度貼片2835LED作為高亮度寬視角光源
- 硅胶材質, 耐候性非常好
- LED數量: 120PCS/M, 側面發光
- 鏤空設計, 散熱性好
- 三面擋光, 發光面蘑菇頭, 可以任意裁剪
- 堵頭特殊設計, 方便造型對接, 對接無暗區
- 燈帶非常柔軟, 方便包裝以及任意造型
- 适用于室內室外

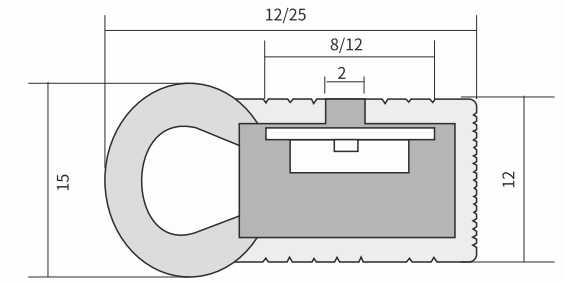

Unit : mm

Specification 產品規格 >>

Model 型號	DC Voltage 電壓	Wattage 功率	Lamp Life 光度壽命	Colour Temp 色溫	Lumen Output 輸出流明	Total Lumen 總流明	Color Rendering 顯色度	Waterproof Grade 防水等級	Size 尺寸
	(V)	(W/M)	(Hrs)	(K)	(Lm/W)	(Lm/M)	(CRI)	(IP)	(mm)
SLB-NL1212-T12MF	12/24	9.6	50000	3000	100	960	>80	IP67	15*12
SLB-NL1525-T12MS	12/24	9.6	50000	3000	100	960	>80	IP67	15*25

- Light efficiency (lm/W), Power (W), Color Rendering Index (CRI), Length can be customized according to customer needs
- Our Standard Power factor (PF) > 0.9 and Total harmonic index THD < 15%, According to customer requirements can produce a lower THD < 10%
- This type of certification is issued by a government-approved laboratory for Safety certification, Fire testing, Restriction of Hazardous Substances (RoHS), Photobiological safety of lamps and lamp systems. (an Exemption Group) and other test certifications to ensure product quality

- 光效 (lm/W)、功率 (W)、顯色指數 (CRI), 長度可根據客戶需求定制
- 此型號標準之功率因素 (PF) > 0.9, 總諧波指數 THD < 15%, 可按客戶需要生產低總諧波指數 < 10%
- 此型號認證由可實驗室發出之安全認證消防測試, 環保物料 (RoHS), 光生物安全為 Exemption Group 及其它測試, 保證客戶使用更安心滿意

T12 Series Neon Light

Series Type: SLB-NL-T12

Features 產品特點 >>

- High brightness patch 2835 LED is adopted as the light source with high brightness and wide Angle of view
- Silicone material, very good weather resistance
- LED Nos: 120PCS/M, side glow
- Hollow design, good heat dissipation
- Three sided light blocking, light emitting flat head, can be cut freely
- The special design of the plug is convenient for shape docking, and there is no dark area in docking
- The light strip is very soft, convenient for packaging and any shape
- Suitable for indoor and outdoor

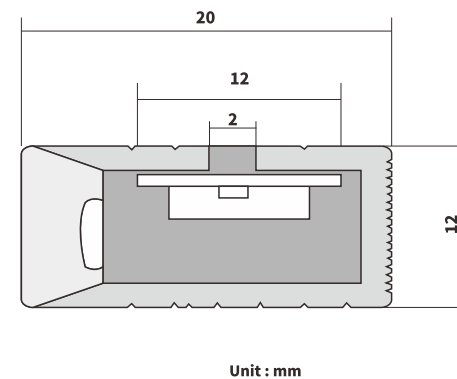

- 採用高亮度貼片2835LED作為高亮度寬視角光源
- 硅胶材質,耐候性非常好
- LED數量: 120PCS/M, 側面發光
- 鏤空設計, 散熱性好
- 三面擋光, 發光面平頭, 可以任意裁剪
- 堵頭特殊設計, 方便造型對接, 對接無暗區
- 燈帶非常柔軟, 方便包裝以及任意造型
- 适用于室內室外

Specification 產品規格 >>

Model 型號	DC Voltage 電壓 (V)	Wattage 功率 (W/M)	Lamp Life 光度壽命 (Hrs)	Colour Temp 色溫 (K)	Lumen Output 輸出流明 (Lm/W)	Total Lumen 總流明 (Lm/M)	Color Rendering 顯色度 (CRI)	Waterproof Grade 防水等級 (IP)	Size 尺寸 (mm)
SLB-NL1220-T12FS	12/24	9.6	50000	3000	100	960	>80	IP67	12*20

- Light efficiency (lm/W), Power (W), Color Rendering Index (CRI), Length can be customized according to customer needs
- Our Standard Power factor (PF) > 0.9 and Total harmonic index THD < 15%, According to customer requirements can produce a lower THD < 10%
- This type of certification is issued by a government-approved laboratory for Safety certification, Fire testing, Restriction of Hazardous Substances (RoHS), Photobiological safety of lamps and lamp systems. (an Exemption Group) and other test certifications to ensure product quality
- 光效 (lm/W)、功率 (W)、顯色指數 (CRI), 長度可根據客戶需求定制
- 此型號標準之功率因素 (PF) > 0.9, 總諧波指數 THD < 15%, 可按客戶需要生產低總諧波指數 < 10%
- 此型號認證由可實驗室發出之安全認證消防測試, 環保物料 (RoHS), 光生物安全為 Exemption Group 及其它測試, 保證客戶使用更安心滿意

T12 Series Neon Light

Series Type: SLB-NL-T12

Features 產品特點 >>

- High brightness patch 2835 LED is adopted as the light source with high brightness and wide Angle of view
- Silicone material, very good weather resistance
- LED Nos: 120PCS/M
- Hollow design, good heat dissipation
- Can be arbitrarily cropped
- The special design of the plug is convenient for shape docking, and there is no dark area in docking
- The light strip is very soft, convenient for packaging and any shape
- Suitable for indoor and outdoor

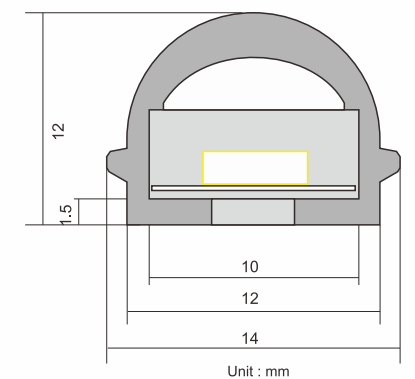

- 採用高亮度貼片2835LED作為高亮度寬視角光源
- 硅胶材質,耐候性非常好
- LED數量: 120PCS/M
- 鏤空設計, 散熱性好
- 可以任意裁剪
- 堵頭特殊設計, 方便造型對接, 對接無暗區
- 燈帶非常柔軟, 方便包裝以及任意造型
- 适用于室內室外

Specification 產品規格 >>

Model 型號	DC Voltage 電壓 (V)	Wattage 功率 (W/M)	Lamp Life 光度壽命 (Hrs)	Colour Temp 色溫 (K)	Lumen Output 輸出流明 (Lm/W)	Total Lumen 總流明 (Lm/M)	Color Rendering 顯色度 (CRI)	Waterproof Grade 防水等級 (IP)	Size 尺寸 (mm)
SLB-NL1412-T12MF	12/24	9.6	50000	3000	100	960	>80	IP67	14*12

- Light efficiency (lm/W), Power (W), Color Rendering Index (CRI), Length can be customized according to customer needs
- Our Standard Power factor (PF) > 0.9 and Total harmonic index THD < 15%, According to customer requirements can produce a lower THD < 10%
- This type of certification is issued by a government-approved laboratory for Safety certification, Fire testing, Restriction of Hazardous Substances (RoHS), Photobiological safety of lamps and lamp systems. (an Exemption Group) and other test certifications to ensure product quality
- 光效 (lm/W)、功率 (W)、顯色指數 (CRI), 長度可根據客戶需求定制
- 此型號標準之功率因素 (PF) > 0.9, 總諧波指數 THD < 15%, 可按客戶需要生產低總諧波指數 < 10%
- 此型號認證由可實驗室發出之安全認證消防測試, 環保物料 (RoHS), 光生物安全為 Exemption Group 及其它測試, 保證客戶使用更安心滿意

T15 Series Neon Light

Series Type: SLB-NL-T15

Features 產品特點 >>

- High brightness patch 2835 LED is adopted as the light source with high brightness and wide Angle of view
- Silicone material, very good weather resistance
- LED Nos: 120PCS/M
- Hollow design, good heat dissipation
- Can be arbitrarily cropped
- The special design of the plug is convenient for shape docking, and there is no dark area in docking
- The light strip is very soft, convenient for packaging and any shape
- Suitable for indoor and outdoor

- 採用高亮度貼片 2835LED 作為高亮度寬視角光源
- 硅胶材質, 耐候性非常好
- LED數量: 120PCS/M
- 鏤空設計, 散熱性好
- 可以任意裁剪
- 堵頭特殊設計, 方便造型對接, 對接無暗區
- 燈帶非常柔軟, 方便包裝以及任意造型
- 适用于室內室外

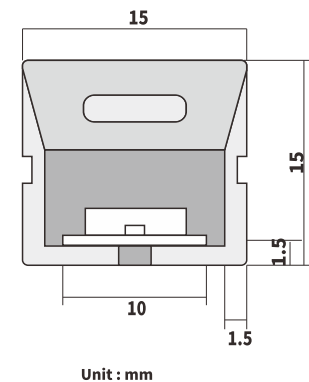

Specification 產品規格 >>

Model 型號	DC Voltage 電壓	Wattage 功率	Lamp Life 光度壽命	Colour Temp 色溫	Lumen Output 輸出流明	Total Lumen 總流明	Color Rendering 顯色度	Waterproof Grade 防水等級	Size 尺寸
	(V)	(W/M)	(Hrs)	(K)	(Lm/W)	(Lm/M)	(CRI)	(IP)	(mm)
SLB-NL1515-T15FF	12/24	9.6	50000	3000	100	960	>80	IP67	15*15

- Light efficiency (lm/W), Power (W), Color Rendering Index (CRI), Length Can be customized according to customer needs
- Our Standard Power factor (PF) > 0.9 and Total harmonic index THD < 15%, According to customer requirements can produce a lower THD < 10%
- This type of certification is issued by a government-approved laboratory for Safety certification, Fire testing, Restriction of Hazardous Substances (RoHS), Photobiological safety of lamps and lamp systems. (an Exemption Group) and other test certifications to ensure product quality

- 光效 (lm/W)、功率 (W)、顯色指數 (CRI), 長度可根據客戶需求定制
- 此型號標準之功率因素 (PF) > 0.9, 總諧波指數 THD < 15%, 可按客戶需要生產低總諧波指數 < 10%
- 此型號認證由可實驗室發出之安全認證消防測試, 環保物料 (RoHS), 光生物安全為 Exemption Group 及其它測試, 保證客戶使用更安心滿意

T15 Series Neon Light

Series Type: SLB-NL-T15

Features 產品特點 >>

- High brightness patch 2835 LED is adopted as the light source with high brightness and wide Angle of view
- Silicone material, very good weather resistance
- LED Nos: 120PCS/M
- Hollow design, good heat dissipation
- Can be arbitrarily cropped
- The special design of the plug is convenient for shape docking, and there is no dark area in docking
- The light strip is very soft, convenient for packaging and any shape
- Suitable for indoor and outdoor

- 採用高亮度貼片 2835LED 作為高亮度寬視角光源
- 硅胶材質, 耐候性非常好
- LED數量: 120PCS/M
- 鏤空設計, 散熱性好
- 可以任意裁剪
- 堵頭特殊設計, 方便造型對接, 對接無暗區
- 燈帶非常柔軟, 方便包裝以及任意造型
- 适用于室內室外

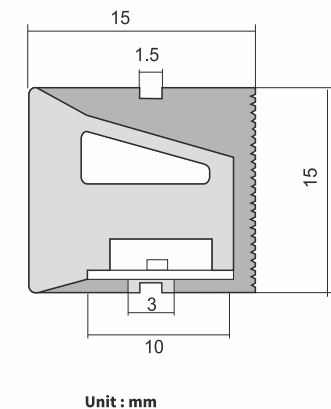
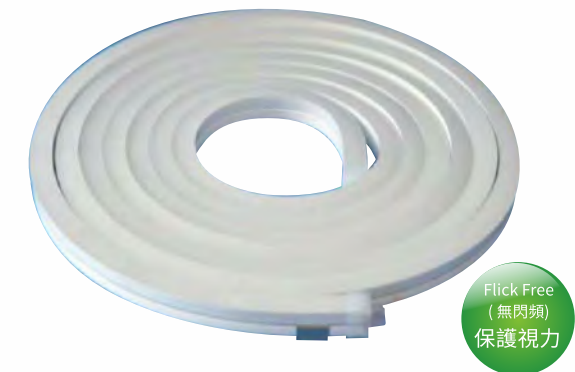

Specification 產品規格 >>

Model 型號	DC Voltage 電壓	Wattage 功率	Lamp Life 光度壽命	Colour Temp 色溫	Lumen Output 輸出流明	Total Lumen 總流明	Color Rendering 顯色度	Waterproof Grade 防水等級	Size 尺寸
	(V)	(W/M)	(Hrs)	(K)	(Lm/W)	(Lm/M)	(CRI)	(IP)	(mm)
SLB-NL1715-T15MF	12/24	9.6	50000	3000	100	960	>80	IP67	16.8*14.5

- Light efficiency (lm/W), Power (W), Color Rendering Index (CRI), Length Can be customized according to customer needs
- Our Standard Power factor (PF) > 0.9 and Total harmonic index THD < 15%, According to customer requirements can produce a lower THD < 10%
- This type of certification is issued by a government-approved laboratory for Safety certification, Fire testing, Restriction of Hazardous Substances (RoHS), Photobiological safety of lamps and lamp systems. (an Exemption Group) and other test certifications to ensure product quality

- 光效 (lm/W)、功率 (W)、顯色指數 (CRI), 長度可根據客戶需求定制
- 此型號標準之功率因素 (PF) > 0.9, 總諧波指數 THD < 15%, 可按客戶需要生產低總諧波指數 < 10%
- 此型號認證由可實驗室發出之安全認證消防測試, 環保物料 (RoHS), 光生物安全為 Exemption Group 及其它測試, 保證客戶使用更安心滿意

T15 Series Neon Light

Series Type: SLB-NL-T15

Features 產品特點 >>

- High brightness patch 2835 LED is adopted as the light source with high brightness and wide Angle of view
- Silicone material, very good weather resistance
- LED Nos: 120PCS/M
- Hollow design, good heat dissipation
- Can be arbitrarily cropped
- The special design of the plug is convenient for shape docking, and there is no dark area in docking
- The light strip is very soft, convenient for packaging and any shape
- Suitable for indoor and outdoor

- 採用高亮度贴片 2835LED 作為高亮度寬視角光源
- 硅胶材質, 耐候性非常好
- LED 數量: 120PCS/M
- 鏤空設計, 散熱性好
- 可以任意裁剪
- 堵頭特殊設計, 方便造型對接, 對接無暗區
- 燈帶非常柔軟, 方便包裝以及任意造型
- 适用于室內室外

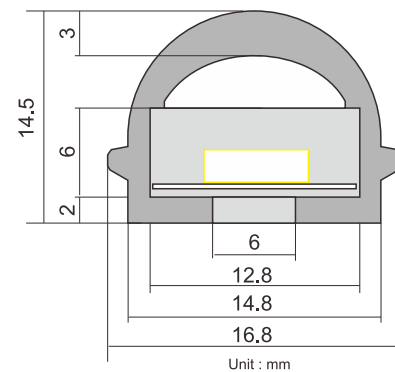

Specification 產品規格 >>

Model 型號	DC Voltage 電壓 (V)	Wattage 功率 (W/M)	Lamp Life 光度壽命 (Hrs)	Colour Temp 色溫 (K)	Lumen Output 輸出流明 (Lm/W)	Total Lumen 總流明 (Lm/M)	Color Rendering 顯色度 (CRI)	Waterproof Grade 防水等級 (IP)	Size 尺寸 (mm)
SLB-NL1515-T15FS	12/24	9.6	50000	3000	100	960	>80	IP67	15*15

- Light efficiency (lm/W), Power (W), Color Rendering Index (CRI), Length can be customized according to customer needs
- Our Standard Power factor (PF) > 0.9 and Total harmonic index THD < 15%, According to customer requirements can produce a lower THD < 10%
- This type of certification is issued by a government-approved laboratory for Safety certification, Fire testing, Restriction of Hazardous Substances (RoHS), Photobiological safety of lamps and lamp systems. (an Exemption Group) and other test certifications to ensure product quality

- 光效 (lm/W)、功率 (W)、顯色指數 (CRI), 長度可根據客戶需求定制
- 此型號標準之功率因素 (PF) > 0.9, 總諧波指數 THD < 15%, 可按客戶需要生產低總諧波指數 < 10%
- 此型號認證由可實驗室發出之安全認證消防測試, 環保物料 (RoHS), 光生物安全為 Exemption Group 及其它測試, 保證客戶使用更安心滿意

LED Flex Neon Light

Series Type: SLB-NL-T10

Features 產品特點 >>

- Top grade silicon material. Good weather resistance
- Top view / bend up & down
- LED Nos: 120 PCS/M
- Hollow design. Good heat dissipation
- Exceptional soft and bright lighting output
- Flexible to bend for easy installation
- Rating IP65. Suitable for indoor and outdoor installation
- With meanwell dimming driver
- Suitable for embedded and surface mounting

- 頂級矽材料, 具有良好的耐候性
- 俯視圖/上下彎曲
- LED 數量: 120個/M
- 中空設計, 散熱良好
- 卓越的柔和明亮的照明輸出
- 彎曲靈活, 便於安裝
- 防護等級 IP65, 適用於室內外安裝
- 帶 meanwell 調光驅動器
- 適用於嵌入式和表面安裝

Optional installation accessories:

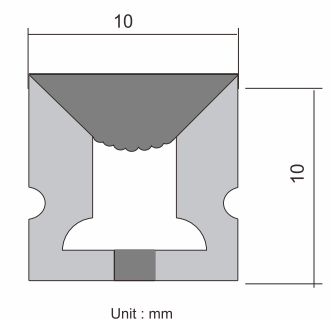

Specification 產品規格 >>

Model 型號	DC Voltage 電壓 (V)	Wattage 功率 (W/M)	Lamp Life 光度壽命 (Hrs)	Colour Temp 色溫 (K)	Beam Angle 光束角度 (°)	Total Lumen 總流明 (Lm/M)	Color Rendering 顯色度 (CRI)	Waterproof Grade 防水等級 (IP)	Size 尺寸 (mm)
SLB-NL1010-T10	24	12.5	up to 30000	4000	120	1000	≥80	IP65	10*10

- Light efficiency (lm/W), Power (W), Color Rendering Index (CRI), Length can be customized according to customer needs
- Our Standard Power factor (PF) > 0.9 and Total harmonic index THD < 15%, According to customer requirements can produce a lower THD < 10%
- This type of certification is issued by a government-approved laboratory for Safety certification, Fire testing, Restriction of Hazardous Substances (RoHS), Photobiological safety of lamps and lamp systems. (an Exemption Group) and other test certifications to ensure product quality

- 光效 (lm/W)、功率 (W)、顯色指數 (CRI), 長度可根據客戶需求定制
- 此型號標準之功率因素 (PF) > 0.9, 總諧波指數 THD < 15%, 可按客戶需要生產低總諧波指數 < 10%
- 此型號認證由可實驗室發出之安全認證消防測試, 環保物料 (RoHS), 光生物安全為 Exemption Group 及其它測試, 保證客戶使用更安心滿意



CABINET LIGHT

櫃燈系列

LED Cabinet Light Small Round

Series Type: KBL-C



Flick Free
(無閃頻)
保護視力

Features 產品特點 >>

- 12mm thickness design, Invisible LED Chip
- Uniform light emission, The beam angle is 180°
- Low Power consumption < 2W
- Other options:(1)1-10V input , Dimmable brightness output
(2)Manual or Remote control function
- Application: Kitchen cabinet, Wine cabinet & Wardrobe, Bathroom cabinet ,Closet, Show cabinet ,etc
- 12毫米厚度設計, 隱形LED晶片
- 發光均勻, 光束角度180°
- 低功耗< 2W
- 其他選項: (1) 1- 10v輸入, 可調亮度輸出
(2) 手動或遙控功能
- 適用範圍: 廚櫃、酒櫃、衣櫃、浴室櫃、衣櫃、陳列櫃等

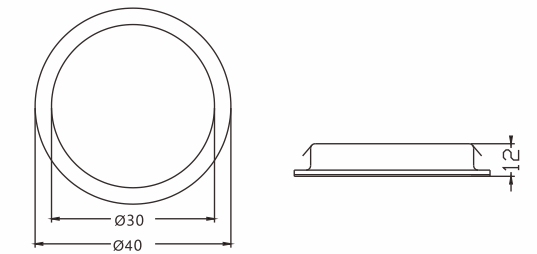

Unit : mm

Specification 產品規格 >>

Model 型號	DC Voltage 電壓	Wattage 功率	Standard Size 標準尺寸	Lamp Life 光度壽命	Colour Temp 色溫	Lumen Output 輸出流明	Color Rendering 顯色度	Hole Size 孔尺寸	Pcs/Box 每箱數量
	(V)	(W)	(mm)	(Hrs)	(K)	(Lm/W)	(CRI)	(mm)	(Pcs)
KBL-C0201-S88E	12/24	1	40*12	50000	3000/4000/6500	80	>93	Ø35	25

- Light efficiency (lm/W), Power (W), Color Rendering Index (CRI), Can be customized according to customer needs
- Our Standard Power factor (PF) > 0.9 and Total harmonic index THD < 15%, According to customer requirements can produce a lower THD < 10%
- This type of certification is issued by a government-approved laboratory for Safety certification, Fire testing, Restriction of Hazardous Substances (RoHS), Photobiological safety of lamps and lamp systems. (an Exemption Group) and other test certifications to ensure product quality

- 光效 (lm/W)、功率 (W)、顯色指數 (CRI), 可根據客戶需求定制
- 此型號標準之功率因素 (PF) > 0.9, 總諧波指數 THD < 15%, 可按客戶需要生產低總諧波指數 < 10%
- 此型號認證由可實驗室發出之安全認證消防測試, 環保物料 (RoHS), 光生物安全為 Exemption Group 及其它測試, 保證客戶使用更安心滿意

LED Cabinet Light Small Square

Series Type: KBL-S

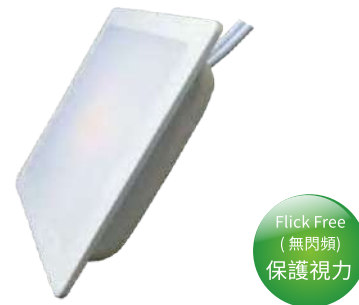

Flick Free
(無閃頻)
保護視力

Features 產品特點 >>

- 12mm thickness design ,Invisible LED Chip
- Uniform light emission, The beam angle is 180°
- Low Power consumption < 2W
- Other options:(1)1-10V input , Dimmable brightness output
(2)Manual or Remote control function
- Application: Kitchen cabinet, Wine cabinet & Wardrobe, Bathroom cabinet ,Closet, Show cabinet ,etc
- 12毫米厚度設計, 隱形LED晶片
- 發光均勻, 光束角度180°
- 低功耗< 2W
- 其他選項: (1) 1- 10v輸入, 可調亮度輸出
(2) 手動或遙控功能
- 適用範圍: 廚櫃、酒櫃、衣櫃、浴室櫃、衣櫃、陳列櫃等

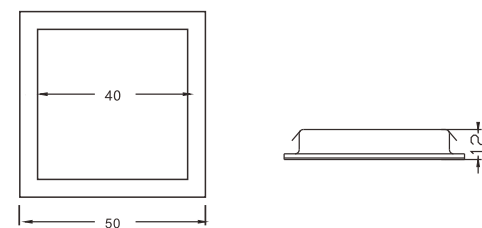

Unit : mm

Specification 產品規格 >>

Model 型號	DC Voltage 電壓	Wattage 功率	Standard Size 標準尺寸	Lamp Life 光度壽命	Colour Temp 色溫	Lumen Output 輸出流明	Color Rendering 顯色度	Hole Size 孔尺寸	Pcs/Box 每箱數量
	(V)	(W)	(mm)	(Hrs)	(K)	(Lm/W)	(CRI)	(mm)	(Pcs)
KBL-S0201-S88E	12/24	1	50*12	50000	3000/4000/6500	80	>93	Ø45	25

- Light efficiency (lm/W),Power (W),Color Rendering Index (CRI), Can be customized according to customer needs
- Our Standard Power factor (PF) > 0.9 and Total harmonic index THD < 15%, According to customer requirements can produce a lower THD< 10%
- This type of certification is issued by a government-approved laboratory for Safety certification, Fire testing, Restriction of Hazardous Substances(RoHS), Photobiological safety of lamps and lamp systems.(an Exemption Group) and other test certifications to ensure product quality

- 光效 (lm/W)、功率 (W)、顯色指數 (CRI), 可根據客戶需求定制
- 此型號標準之功率因素 (PF)>0.9, 總諧波指數THD<15%, 可按客戶需要生產低總諧波指數<10%
- 此型號認證由可實驗室發出之安全認證消防測試, 環保物料 (RoHS), 光生物安全為Exemption Group及其它測試, 保證客戶使用更安心滿意

LED Cabinet Light Big Round

Series Type: KBL-C



Flick Free
(無閃頻)
保護視力

Features 產品特點 >>

- 12mm thickness design, Invisible LED Chip
- Uniform light emission, The beam angle is 180°
- Low Power consumption < 2W
- Other options:(1)1-10V input , Dimmable brightness output
(2)Manual or Remote control function
- Application: Kitchen cabinet, Wine cabinet & Wardrobe, Bathroom cabinet ,Closet, Show cabinet ,etc
- 12毫米厚度設計,隱形LED晶片
- 發光均勻, 光束角度180°
- 低功耗< 2W
- 其他選項: (1) 1- 10v輸入, 可調亮度輸出
(2) 手動或遙控功能
- 適用範圍: 廚櫃、酒櫃、衣櫃、浴室櫃、衣櫃、陳列櫃等

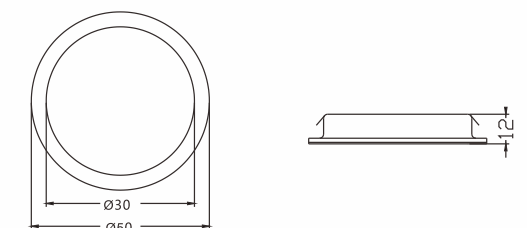

Unit : mm

Specification 產品規格 >>

Model 型號	DC Voltage 電壓	Wattage 功率	Standard Size 標準尺寸	Lamp Life 光度壽命	Colour Temp 色溫	Lumen Output 輸出流明	Color Rendering 顯色度	Hole Size 孔尺寸	Pcs/Box 每箱數量
	(V)	(W)	(mm)	(Hrs)	(K)	(Lm/W)	(CRI)	(mm)	(Pcs)
KBL-C0302	12/24	2	50*12	50000	3000/4000/6500	100	>80	Ø45	25

- Light efficiency (lm/W),Power (W),Color Rendering Index (CRI), Can be customized according to customer needs
- Our Standard Power factor (PF) > 0.9 and Total harmonic index THD < 15%, According to customer requirements can produce a lower THD< 10%
- This type of certification is issued by a government-approved laboratory for Safety certification, Fire testing, Restriction of Hazardous Substances(RoHS), Photobiological safety of lamps and lamp systems.(an Exemption Group) and other test certifications to ensure product quality

- 光效 (lm/W)、功率 (W)、顯色指數 (CRI), 可根據客戶需求定制
- 此型號標準之功率因素 (PF)>0.9, 總諧波指數THD<15%, 可按客戶需要生產低總諧波指數<10%
- 此型號認證由可實驗室發出之安全認證消防測試, 環保物料 (RoHS), 光生物安全為Exemption Group及其它測試, 保證客戶使用更安心滿意

Recessed LED Cabinet Light Surface Round

Series Type: KBL-IB



Features 產品特點 >>

- 12mm thickness design ,Invisible LED Chip
- Uniform light emission, The beam angle is 180°
- Low Power consumption < 2W
- Other options:(1)1-10V input , Dimmable brightness output
(2)Manual or Remote control function
- Application: Kitchen cabinet, Wine cabinet & Wardrobe, Bathroom cabinet ,Closet, Show cabinet ,etc
- 12毫米厚度設計,隱形LED晶片
- 發光均勻,光束角度180°
- 低功耗<2W
- 其他選項:(1)1-10v輸入,可調亮度輸出
(2)手動或遙控功能
- 適用範圍:廚櫃、酒櫃、衣櫃、浴室櫃、衣櫃、陳列櫃等

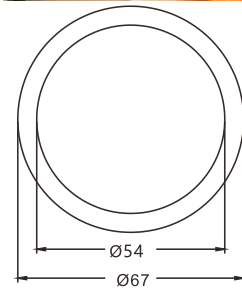

Unit : mm

Specification 產品規格 >>

Model 型號	DC Voltage 電壓	Wattage 功率	Standard Size 標準尺寸	Lamp Life 光度壽命	Colour Temp 色溫	Lumen Output 輸出流明	Color Rendering 顯色度	Hole Size 孔尺寸	Pcs/Box 每箱數量
	(V)	(W)	(mm)	(Hrs)	(K)	(Lm/W)	(CRI)	(mm)	(Pcs)
KBL-IB0302-S88E	12/24	1	67*12	50000	3000/4000/6500	80	>93	Ø67	25

- Light efficiency (lm/W),Power (W),Color Rendering Index (CRI), Can be customized according to customer needs
- Our Standard Power factor (PF) > 0.9 and Total harmonic index THD < 15%, According to customer requirements can produce a lower THD < 10%
- This type of certification is issued by a government-approved laboratory for Safety certification, Fire testing, Restriction of Hazardous Substances(RoHS), Photobiological safety of lamps and lamp systems.(an Exemption Group) and other test certifications to ensure product quality

- 光效 (lm/W)、功率 (W)、顯色指數 (CRI), 可根據客戶需求定制
- 此型號標準之功率因素 (PF) > 0.9, 總諧波指數 THD < 15%, 可按客戶需要生產低總諧波指數 < 10%
- 此型號認證由可實驗室發出之安全認證消防測試, 環保物料 (RoHS), 光生物安全為 Exemption Group 及其它測試, 保證客戶使用更安心滿意

Recessed LED Cabinet Light

Series Type: KBL-0302



Features 產品特點 >>

- 12mm thickness design, Invisible LED Chip
- Uniform light emission, The beam angle is 180°
- Low Power consumption < 2W, Shell color: white/black/silver
- Other options:(1)1-10V input , Dimmable brightness output
(2)Manual or Remote control function
- Application: Kitchen cabinet, Wine cabinet & Wardrobe, Bathroom cabinet ,Closet, Show cabinet ,etc
- 12毫米厚度設計,隱形LED晶片
- 發光均勻,光束角度180°
- 低功耗<2W,外殼顏色:白/黑/銀
- 其他選項:(1)1-10v輸入,可調亮度輸出
(2)手動或遙控功能
- 適用範圍:廚櫃、酒櫃、衣櫃、浴室櫃、衣櫃、陳列櫃等

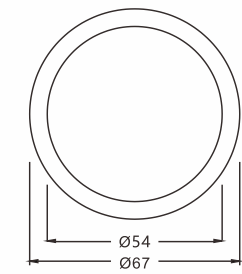

Unit : mm

Specification 產品規格 >>

Model 型號	DC Voltage 電壓	Wattage 功率	Standard Size 標準尺寸	Lamp Life 光度壽命	Colour Temp 色溫	Lumen Output 輸出流明	Color Rendering 顯色度	Hole Size 孔尺寸	Pcs/Box 每箱數量
	(V)	(W)	(mm)	(Hrs)	(K)	(Lm/W)	(CRI)	(mm)	(Pcs)
KBL-0302	12/24	2	67*12	50000	3000/4000/6500	100	>80	Ø58	25

- Light efficiency (lm/W),Power (W),Color Rendering Index (CRI), Can be customized according to customer needs
- Our Standard Power factor (PF) > 0.9 and Total harmonic index THD < 15%, According to customer requirements can produce a lower THD < 10%
- This type of certification is issued by a government-approved laboratory for Safety certification, Fire testing, Restriction of Hazardous Substances(RoHS), Photobiological safety of lamps and lamp systems.(an Exemption Group) and other test certifications to ensure product quality

- 光效 (lm/W)、功率 (W)、顯色指數 (CRI), 可根據客戶需求定制
- 此型號標準之功率因素 (PF) > 0.9, 總諧波指數 THD < 15%, 可按客戶需要生產低總諧波指數 < 10%
- 此型號認證由可實驗室發出之安全認證消防測試, 環保物料 (RoHS), 光生物安全為 Exemption Group 及其它測試, 保證客戶使用更安心滿意

LED Cabinet Light

Series Type: KBL-PIR

Features 產品特點 >>

- 40mm thickness design ,Invisible LED Chip
- Uniform light emission,The beam angle is 180°
- Light weight only 122g
- PIR : 2-3meter detect area,Hold time 30 sec if nobody
- Application: Kitchen cabinet, Wine cabinet & Wardrobe, Show cabinet ,etc
- 40毫米厚度設計,隱形LED晶片
- 發光均勻,光束角度180°
- 重量輕,僅122g
- PIR:2-3米探測區,無人時保持30秒
- 適用範圍: 廚櫃、酒櫃及衣櫃、展示櫃等

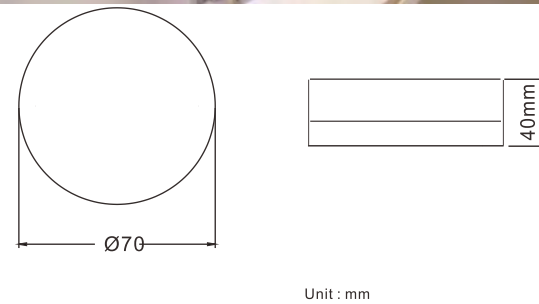
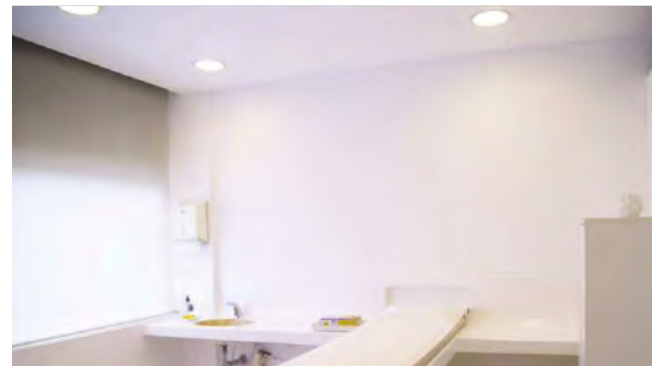

Specification 產品規格 >>

Model 型號	DC Voltage 電壓 (V)	Wattage 功率 (W)	Standard Size 標準尺寸 (mm)	Lamp Life 光度壽命 (Hrs)	Colour Temp 色溫 (K)	Lumen Output 輸出流明 (Lm/W)	Color Rendering 顯色度 (CRI)	Operation temperature 工作溫度 (°C)	Pcs/Box 每箱數量 (Pcs)
KBL-0401-PIR	5	1	70*40	50000	3000/4000/6500	80	>90	-10~ 40	25

- Light efficiency (lm/W),Power (W),Color Rendering Index (CRI), Can be customized according to customer needs
- Our Standard Power factor (PF) > 0.9 and Total harmonic index THD < 15%, According to customer requirements can produce a lower THD< 10%
- This type of certification is issued by a government-approved laboratory for Safety certification, Fire testing, Restriction of Hazardous Substances(RoHS), Photobiological safety of lamps and lamp systems.(an Exemption Group) and other test certifications to ensure product quality
- 光效 (lm/W)、功率 (W)、顯色指數 (CRI), 可根據客戶需求定制
- 此型號標準之功率因素 (PF)>0.9, 總諧波指數THD<15%, 可按客戶需要生產低總諧波指數< 10%
- 此型號認證由可實驗室發出之安全認證消防測試, 環保物料 (RoHS), 光生物安全為Exemption Group及其它測試, 保證客戶使用更安心滿意

Recessed LED Cabinet Light

Series Type: KBL-0303

Features 產品特點 >>

- 13mm thickness design, invisible LED Chip
- Uniform light emission, The beam angle is 180°
- Shell color white/black/silver
- Application: Kitchen cabinet, Wine cabinet & Wardrobe, Bathroom cabinet ,Closet, Show cabinet ,etc
- 13毫米厚度設計,隱形LED晶片
- 發光均勻,光束角度180°
- 外殼顏色白色/黑色/銀色
- 適用範圍: 廚櫃、酒櫃、衣櫃、浴室櫃、衣櫃、陳列櫃等

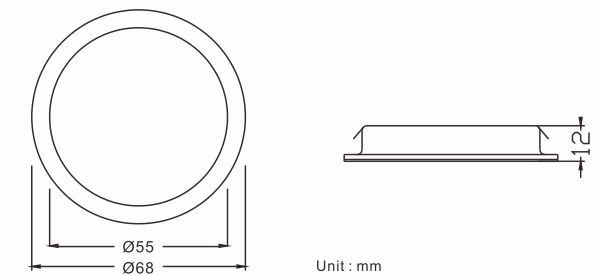

Specification 產品規格 >>

Model 型號	DC Voltage 電壓 (V)	Wattage 功率 (W)	Standard Size 標準尺寸 (mm)	Lamp Life 光度壽命 (Hrs)	Colour Temp 色溫 (K)	Lumen Output 輸出流明 (Lm/W)	Color Rendering 顯色度 (CRI)	Hole Size 孔尺寸 (mm)	Pcs/Box 每箱數量 (Pcs)
KBL-0303	12	3	Ø68*13	30000	3000/4000/6500	90	>80	Ø58	25

- Light efficiency (lm/W),Power (W),Color Rendering Index (CRI), Can be customized according to customer needs
- Our Standard Power factor (PF) > 0.9 and Total harmonic index THD < 15%, According to customer requirements can produce a lower THD< 10%
- This type of certification is issued by a government-approved laboratory for Safety certification, Fire testing, Restriction of Hazardous Substances(RoHS), Photobiological safety of lamps and lamp systems.(an Exemption Group) and other test certifications to ensure product quality
- 光效 (lm/W)、功率 (W)、顯色指數 (CRI), 可根據客戶需求定制
- 此型號標準之功率因素 (PF)>0.9, 總諧波指數THD<15%, 可按客戶需要生產低總諧波指數< 10%
- 此型號認證由可實驗室發出之安全認證消防測試, 環保物料 (RoHS), 光生物安全為Exemption Group及其它測試, 保證客戶使用更安心滿意

1-6 without the line

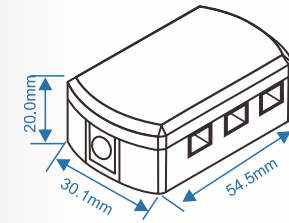

Model	CJB-1IN60-2P
Material	PC
Control	No Switch
1 Input (V)	DC12V/DC24V
6 Output (V)	DC12V/DC24V

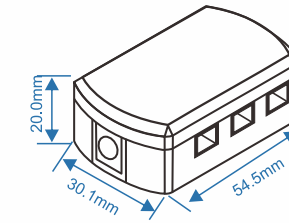

Model	CJB-1IN1SW50-2P
Material	PC
Control	1 Switch
1 Input (V)	DC12V/DC24V
5 Output (V)	DC12V/DC24V

1-10 with the line

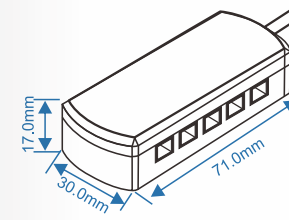

Model	CJB-1IN10-2P
Material	PC
Standard Size (mm)	71*30X17
1 Input (V)	DC12V/DC24V
10 Output (V)	DC12V/DC24V

1-12 with the line

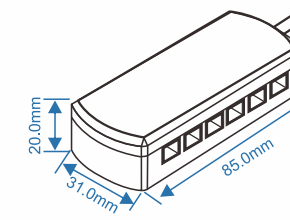

Model	CJB-1W10-2P-L
Material	PC
Standard Size (mm)	85*31*20
1 Input (V)	DC12V/DC24V
12 Output (V)	DC12V/DC24V

1-6 with the line

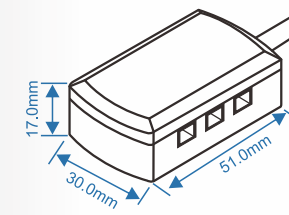

Model	CJB-1IN60-2P-SL
Material	PC
Standard Size (mm)	51*30X17
1 Input (V)	DC12V/DC24V
6 Output (V)	DC12V/DC24V

1-6 with the line

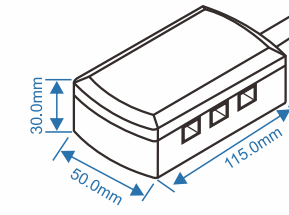

Model	CJB-1N60-2P-DC
Material	PC
Standard Size (mm)	115*50*30
1 Input (V)	DC12V/DC24V
6 Output (V)	DC12V/DC24V

1-4 with the line

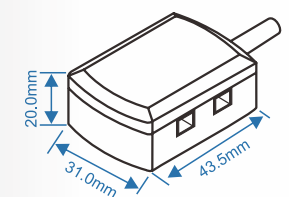

Model	CJB-CJB-1N40-2P-L
Material	PC
Standard Size (mm)	43.5*31*20
1 Input (V)	DC12V/DC24V
6 Output (V)	DC12V/DC24V

1-4 with the line

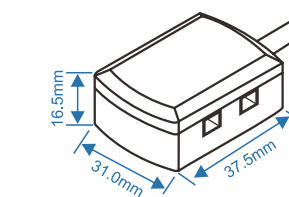

Model	CJB-1INN40-2P-SL
Material	PC
Standard Size (mm)	37.5*31*16.5
1 Input (V)	DC12V/DC24V
4 Output (V)	DC12V/DC24V

Junction Box

接線盒

Installation Buckle & Clamp

安裝扣和卡箍

